

ORTEC[®]

A portable neutron and gamma nuclide identifier device, model Detective-EX/DX-100T. It is a white, rectangular unit with a black handle on top and a black carrying case attached to the front. The device has a circular lens or detector window on the front and a small display or control panel on the top. The ORTEC logo is visible on the front panel.

Detective-EX/DX[®]-100T

Portable Neutron and Gamma Nuclide Identifier

User's Manual

Advanced Measurement Technology, Inc.
("AMT")

WARRANTY

AMT warrants that the items will be delivered free from defects in material or workmanship. AMT makes no other warranties, express or implied, and specifically NO WARRANTY OF MERCHANTABILITY OR FITNESS FOR A PARTICULAR PURPOSE.

AMT's exclusive liability is limited to repairing or replacing at AMT's option, items found by AMT to be defective in workmanship or materials within one year from the date of delivery. AMT's liability on any claim of any kind, including negligence, loss, or damages arising out of, connected with, or from the performance or breach thereof, or from the manufacture, sale, delivery, resale, repair, or use of any item or services covered by this agreement or purchase order, shall in no case exceed the price allocable to the item or service furnished or any part thereof that gives rise to the claim. In the event AMT fails to manufacture or deliver items called for in this agreement or purchase order, AMT's exclusive liability and buyer's exclusive remedy shall be release of the buyer from the obligation to pay the purchase price. In no event shall AMT be liable for special or consequential damages.

Quality Control

Before being approved for shipment, each AMT instrument must pass a stringent set of quality control tests designed to expose any flaws in materials or workmanship. Permanent records of these tests are maintained for use in warranty repair and as a source of statistical information for design improvements.

Repair Service

If it becomes necessary to return this instrument for repair, it is essential that Customer Services be contacted in advance of its return so that a Return Authorization Number can be assigned to the unit. Also, AMT must be informed, either in writing, by telephone [(865) 482-4411] or by facsimile transmission [(865) 483-2133], of the nature of the fault of the instrument being returned and of the model, serial, and revision ("Rev" on rear panel) numbers. Failure to do so may cause unnecessary delays in getting the unit repaired. The AMT standard procedure requires that instruments returned for repair pass the same quality control tests that are used for new-production instruments. Instruments that are returned should be packed so that they will withstand normal transit handling and must be shipped PREPAID via Air Parcel Post or United Parcel Service to the designated AMT repair center. The address label and the package should include the Return Authorization Number assigned. Instruments being returned that are damaged in transit due to inadequate packing will be repaired at the sender's expense, and it will be the sender's responsibility to make claim with the shipper. Instruments not in warranty should follow the same procedure and AMT will provide a quotation.

Damage in Transit

Shipments should be examined immediately upon receipt for evidence of external or concealed damage. The carrier making delivery should be notified immediately of any such damage, since the carrier is normally liable for damage in shipment. Packing materials, waybills, and other such documentation should be preserved in order to establish claims. After such notification to the carrier, please notify AMT of the circumstances so that assistance can be provided in making damage claims and in providing replacement equipment, if necessary.

Copyright © 2014, Advanced Measurement Technology, Inc. All rights reserved.

ORTEC® is a registered trademark of Advanced Measurement Technology, Inc. All other trademarks used herein are the property of their respective owners.

NOTICE OF PROPRIETARY PROPERTY — This document and the information contained in it are the proprietary property of AMETEK Inc. It may not be copied or used in any manner nor may any of the information in or upon it be used for any purpose without the express written consent of an authorized agent of AMETEK Inc.

ADDITIONAL WARRANTY STATEMENT

Please note that the computer that controls the Detective-EX/DX-100T is intended exclusively for the tasks detailed in this manual. Using this computer for any other purpose ***could void your warranty.***

In addition, the Detective-EX/DX-100T contains ***no user-serviceable parts.*** Except for the battery hatch on the left side panel, which can be opened when the battery requires replacement, breaking the seal on the case ***voids your warranty.*** The Detective-EX/DX-100T should be opened only by ORTEC-authorized service personnel.

If you have any questions about the use or maintenance of this instrument, please contact your ORTEC representative or our Global Service Center first.

IMPORTANT

*The Detective-EX/DX-100T is designed to function with the Regional Settings in Microsoft® Windows® Mobile™ set to the English (United States) region and all of its default settings, as discussed in Section 7.12. **Using other than the factory default settings can cause operational problems.***

[Intentionally blank]

TABLE OF CONTENTS

WARRANTY	ii
ADDITIONAL WARRANTY STATEMENT	iii
Safety Instructions and Symbols	ix
Cleaning Instructions	ix
1. INTRODUCTION	1
1.1. Monitoring Modes	1
1.2. Hardware Features	3
1.3. How This Manual Is Organized	4
1.4. Spectrum and Search File Storage, Transfer, and Viewing	5
1.4.1. Saving Spectra and Searches	6
1.4.2. File Formats and Filenaming Conventions	6
1.4.2.1. Identification Mode Spectra	6
1.4.2.2. Search Mode “Strip Charts”	7
1.4.2.3. The Background File	7
1.5. A Note About the DX and DX-100 User Interface	7
1.6. The “Launcher” Interface for Multiple Identifier Applications	8
2. THE DETECTIVE-EX/DX-100T	9
2.1. Unpacking and Setup	9
2.2. The Detective-EX/DX-100T	10
2.2.1. Front Panel	10
2.2.2. Rear-Panel Connectors	12
2.2.3. The Touchscreen	12
2.2.4. Attaching the Carrying Strap	13
2.3. The Docking Station	14
2.3.1. Connectors and Indicators	14
2.3.2. Strapping the Detective-EX to the Docking Station	15
2.4. The PAC-II Charger	15
2.5. The Automobile Accessory Adapter	16
2.6. Internal and External Power	16
2.6.1. A Note on Internal vs External Battery Power	17
2.6.2. Replacing the Internal Battery	18
2.7. Operating Cautions and Notes	18
2.8. Startup and Cooldown	19
2.8.1. Connecting the Detective-EX to the Charger Base and Powering It On	20
2.8.2. Turning On the Mechanical Cooler	21

- 2.9. The User Interface 22
 - 2.9.1. Instrument Status Indicators 22
 - 2.9.2. Moving Through the Menus 22
- 2.10. Selecting the Data Storage Location and File Formats 23
- 2.11. Checking the Calibration 23
- 2.12. Running A New Background After Calibration 25
- 2.13. Optional: Restricting Access to the Advanced Settings 27

- 3. RADIATION MONITORING 29
 - 3.1. Survey (Count-Rate/Dose-Rate) Mode 29
 - 3.2. Identification Mode 31
 - 3.2.1. Start the Identification 32
 - 3.2.2. Extending the Count-to-Preset 33
 - 3.2.3. Save 33
 - 3.2.4. View Found Nuclides List for Classify ID Display Mode 33
 - 3.2.5. Intense (View Highest-Intensity Spectrum Lines) 34
 - 3.2.6. Display Spectrum 35
 - 3.2.6.1. Display Controls 35
 - 3.3. Search Mode 36
 - 3.4. Monitor Mode 37
 - 3.5. SNM Search Mode 38

- 4. IDENTIFICATION MESSAGES AND RADIONUCLIDE LIBRARY 41
 - 4.1. Comments on Classify Mode Messages 45
 - 4.1.1. Comments on “Found Nuclide” Screen Messages 46

- 5. ADVANCED SETUP 47
 - 5.1. Advanced Setup — Page 1 47
 - 5.1.1. Status 47
 - 5.1.2. Turn Cooler Off/On 49
 - 5.1.3. Calibrate (Manual) 49
 - 5.1.3.1. Start the Calibration 49
 - 5.1.3.2. Apply the Improved Calibration 50
 - 5.1.3.3. Perform a Background Measurement 51
 - 5.1.3.4. Restore Default 51
 - 5.1.3.5. Back 52
 - 5.1.4. Background 52
 - 5.1.5. List Nuclides (View Analysis Library) 52
 - 5.1.6. Recall Spectra 52
 - 5.1.6.1. Viewing Stored Spectra 53
 - 5.1.6.2. Viewing Stored Spectrum Reports 53

5.1.7. About	56
5.2. Advanced Setup — Page 2	56
5.2.1. Calibration Settings and Auto-Calibration	57
5.2.1.1. Setup Requirements for Successful Auto-Calibration	58
5.2.1.2. Auto-Calibration	59
5.2.2. Background Settings	59
5.2.3. Identify (Identification Mode) Settings	60
5.2.3.1. Real Time Preset	60
5.2.3.2. ID Display Mode	60
5.2.3.3. LCX (Low-Confidence Expert) ID Mode	60
5.2.3.4. Color Coded IDs	61
5.2.4. Settings	61
5.2.4.1. Password	61
5.2.4.2. Allow Display of Spectrum	62
5.2.4.3. GPS Port	62
5.2.5. Search Mode Settings	63
5.2.6. SNM Mode Settings	63
5.2.7. Dose-Rate Units and Alarms	64
5.2.8. Audio Settings	65
5.3. Advanced Setup — Page 3	66
5.3.1. Remote	66
5.3.2. Exit	66
5.3.3. Spectra	66
5.3.3.1. Ask for Sample Description	66
5.3.3.2. Default Description	67
5.3.3.3. Data Location	67
5.3.3.4. File Save Format	67
5.3.3.5. Delete Stored Spectra	67
6. FILE TRANSFER TO COMPUTER	69
6.1. Windows 8 and 7	69
6.2. Windows XP	71
6.3. When File Transfer Is Complete	73
7. TROUBLESHOOTING	75
7.1. “Error Saving .SPC File” Message	75
7.2. If the DetectiveEX Program Stops	75
7.3. If You Drop the Detective-EX	75
7.4. If the Detective-EX Will Not Turn On	76
7.5. If the Docking Station Spontaneously Shuts Down and Restarts	76
7.6. If the Display is Lost or Posts a “Display Disabled” Message	76

- 7.7. If You Forgot the Password 77
- 7.8. Calibration Issues 77
 - 7.8.1. Calibration Takes Very Long to Complete or Does Not Finish at All 77
 - 7.8.2. The Centroid, FWHM, or Calibration Adjustment Value Has Changed Dramatically Since the Last Calibration 77
- 7.9. GPS Issues 78
 - 7.9.1. Delayed Display of Location Coordinates 78
 - 7.9.2. “GPS Not Communicating” 78
- 7.10. Windows Connectivity Problems 78
- 7.11. Troubleshooting MAESTRO-Related Problems 79
 - 7.11.1. MAESTRO Does Not Connect with the Detective-EX 79
- 7.12. Other Problems with the Detective-EX 79

- 8. USING THE DETECTIVE-EX WITH ORTEC SPECTRUM ANALYSIS PROGRAMS . 81
 - 8.1. Connecting the Detective-EX to a Computer 81
 - 8.2. Quantitative Analysis of Detective-EX Spectra in GammaVision and ISOTOPIC . . . 82
 - 8.3. Detective-EX MCB Properties in MAESTRO 83
 - 8.3.1. Amplifier 84
 - 8.3.2. Amplifier 2 85
 - 8.3.3. Amplifier PRO 85
 - 8.3.4. ADC 86
 - 8.3.5. High Voltage 86
 - 8.3.6. Reports 87
 - 8.3.7. About 87
 - 8.3.8. Status 88
 - 8.3.9. Presets 89

- 9. SPECIFICATIONS 91
 - 9.1. Electrical and Mechanical 94
 - 9.2. Connectors 95
 - 9.3. Docking Station 95
 - 9.4. PAC-II Power Adapter/Charger 96
 - 9.5. Computer Prerequisites 96
 - 9.6. Shipping the Detective-EX 96
 - 9.7. Long-Term Shutdown/Storage 96

- 10. CHANGING THE INTERNAL BATTERY 99

- 11. CALIBRATION SOURCE STATEMENT 101

- INDEX 103

Safety Instructions and Symbols

This manual contains up to three levels of safety instructions that must be observed in order to avoid personal injury and/or damage to equipment or other property. These are:

DANGER Indicates a hazard that could result in death or serious bodily harm if the safety instruction is not observed.

WARNING Indicates a hazard that could result in bodily harm if the safety instruction is not observed.

CAUTION Indicates a hazard that could result in property damage if the safety instruction is not observed.

In addition, the following symbols may appear on the product:



DANGER – Hazardous voltage



ATTENTION – Consult the manual in all cases where this symbol is marked in order to determine the nature of the potential hazards and any actions that must be taken to avoid them



Protective earth (ground) terminal

Please read all safety instructions carefully and make sure you understand them fully before attempting to use this product.

Cleaning Instructions

To clean the instrument exterior:

- Disconnect the instrument from the power source.
- Remove loose dust on the outside of the instrument with a lint-free cloth.
- Remove remaining dirt with a lint-free cloth dampened in a general-purpose detergent and water solution. Do not use abrasive cleaners.

<p>CAUTION To prevent moisture inside of the instrument during external cleaning, use only enough liquid to dampen the cloth or applicator.</p>
--

- Allow the instrument to dry completely before reconnecting it to the power source.



1. INTRODUCTION

The ORTEC Detective-EX[®]-100T portable nuclide identifier uses both a high-purity germanium (HPGe) detector for identification using gamma-ray emissions and a moderated neutron detector for detection of the neutron emissions. The Detective-DX-100T is identical to the -EX-100T but has no neutron detector.¹ The HPGe detector is cooled by a miniature, high-reliability mechanical cooler — no liquid nitrogen is required. The user interface is a high-resolution color touchscreen. The result is a lightweight and rugged instrument that delivers unmatched identification and detection for the needs of nuclear security.

The Detective-EX identifies and classifies radionuclides according to the requirements of ANSI N42.34 and other standards. The radionuclide library for this release of the Detective-EX is detailed in Chapter 4.²

The Detective-EX can make an accurate and fast determination without the need for expert human intervention. Nuclide identifications are based on the gamma-ray peaks in the spectrum and on other aspects of the total spectrum.

1.1. Monitoring Modes

The Detective-EX has five radioactivity-monitoring modes; see also the diagram in Fig. 1.

- **Survey Mode** — In this “home screen” mode, the Detective-EX displays gamma count-rate, gamma dose-rate meter (and neutron dose-rate meter, where applicable), a battery-life indicator, and an icon indicating the current power source (e.g., internal battery, power adapter/charger), detector dead (busy) time, and available disk storage.
- **Identification Mode** — This mode is used to identify radionuclides from a stationary object of interest. Data can be collected for an arbitrarily long period to ensure very low false-positive rates. You can optionally view the spectrum and the 10 most intense gamma-ray lines in real-time. The data used for the analysis and the identification results can be quickly saved in the `.N42` and/or ORTEC `.SPC` file formats, providing backup for the displayed result and later analysis.³

¹In this manual, the term Detective-EX refers to all members of this instrument family, exceptions noted. See also Section 1.5.

²Other lists of nuclides can be supplied on special order.

³Measurements with a portable identifiers cannot take into account the counting geometry and source shielding, so the Detective-EX-100T does not determine the quantity of the detected nuclides.

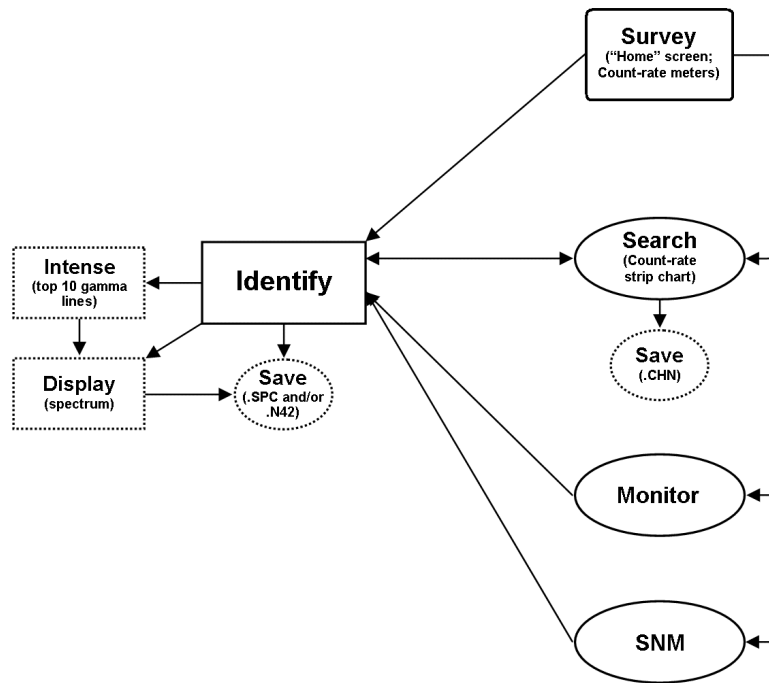

Figure 1. Detective-EX Monitoring Modes.

- **Monitor Mode** — Monitor Mode is used to identify radionuclides while moving relative to object(s) of interest. In this mode, the Detective-EX collects and analyzes data in rolling 8-second windows, making it particularly suited to situations where a completely different set of objects may be presented to the instrument in that time period. An example application is an *ad hoc* portal monitor where packages or people pass by the instrument. This mode is also useful as a search tool where the instrument is carried by the user in an effort to locate and identify a radioactive source. IDs persist until you tap to acknowledge them; this ensures none go unnoticed.
- **Search Mode** — Search Mode makes it easy to find the areas of highest radionuclide activity, that is, places where Identification Mode should be used. The display shows the total gamma-ray count rate and total neutron count rate in each time period of the last 221 time periods in a rolling “strip chart” display. The time period is selectable. The neutron count rates and gamma dose rate are also displayed. These strip-chart data can be saved on disk in the ORTEC .CHN file format.
- **SNM Search Mode⁴** — This mode lets you quickly sense the possible presence of special nuclear materials ²³⁵U and ²³⁹Pu, even if other radioactive materials are present. It

⁴Patent pending.

is designed for rapid area searches as well as fast scanning of containers or vehicles. Use it to locate possible SNM, then test more rigorously using Identification Mode. SNM Search Mode also takes advantage of the fact that the comparatively innocuous ^{133}Ba can be used as a plutonium surrogate. Advanced users can choose to enable a “search for ^{133}Ba ” feature within SNM Search Mode both for training purposes and for developing a site’s concept of operations.

Before using SNM Search Mode in the field, you must develop your concept of operations for most effective use. The Detective-EX allows you to adjust the length of the SNM data sampling (“dwell”) time. ORTEC specialists are available to help you optimize the instrument settings; contact your ORTEC representative or our Global Service Center.

In all modes, when the gamma dose rate exceeds 10,000 $\mu\text{Sv/hr}$ (1 rem/hr) or the neutron count rate exceeds 500 cps, both audible and visual alarms warn you immediately of the high radiation field. You can optionally set the alarm threshold(s) to lower settings.

Search and identification data can be viewed on the display for further analysis. For work in sensitive areas, the spectrum display can be disabled.

1.2. Hardware Features

- The Detective-EX’s integrated Computer runs under Microsoft® Windows® Mobile™, with the Detective-EX software as the only program running. The operation of the software is controlled by soft buttons in much the same way as any other Windows program. A soft keyboard is automatically displayed when any alphanumeric input is needed. The color touchscreen has large soft keys for easy use with bulky gloves, and an audible gamma count-rate signal with adjustable volume. Instrument setup can be viewed and changed to ensure correct operation. Access to all the setup parameters is password protected as set in the Advanced Setup dialog, accessed by tapping the **Advanced** button.
- The unit comes with either a docking station or the more compact PAC-II power adapter/charger (collectively referred to as *charger bases*). Both types of charger base contain the charger for the internal battery. The docking station’s fans both cool the charger unit and dissipate heat from the Detective-EX when the unit is docked. The docking station can also hold a weak (~ 37 kBq) ^{137}Cs source used to verify the energy calibration.

The Detective-EX can operate for about 3 hours on its internal lithium-ion battery. The car accessory connector (included) allows you to use 12-V power from an automobile battery. In addition, ORTEC offers optional battery belts to extend the remote operation time.

- Checking the Detective-EX's calibration is easy, whether you have a docking station with its built-in ^{137}Cs source; a PAC-II charger, which does not include a calibration source; or are working in the field under battery power. The Detective-EX allows you to choose the calibration source that best suits your needs — even the ^{40}K naturally present in concrete or low-sodium salt substitute.
- The Detective-EX includes global positioning (GPS) hardware, and where GPS signals can be detected, the upper right corner of the screen includes the current latitude and longitude, as shown in Fig. 14 on page 22. The GPS coordinates are captured and stored at the start of each identification acquisition, saved as part of .SPC or .N42 spectrum files, and available as one of reports discussed in Section 5.1.6.2.
- The Detective-EX is equipped with IEEE 802.11b wireless connectivity. Third-party software can be used to implement wireless communication. See the *Detective-EX Wireless Remote Operation* note, P/N 932735).

Before using the Detective-EX, it must be set up and cooled; and the calibration should be checked according to the instructions in Chapter 2.8. The instrument is shipped fully calibrated and is likely to still be correctly calibrated, but checking the calibration is considered good practice.

1.3. How This Manual Is Organized

This release of the Detective-EX combines the “operator” and “administrator” functions into one manual. Chapters 2 and 3 cover topics germane to everyday radiation monitoring tasks. The remaining chapters are aimed more at administrator-level users and expert spectroscopists.

“Operator-oriented” chapters:

- Chapter 1 — System features, spectrum storage, file formats, and filename conventions.
- Chapter 2 — Unpacking, startup, operating limits, initial configuration, and user-interface overview.
- Chapter 3 — Using the Detective-EX to monitor and identify radiation sources.
- Chapter 4 — Radionuclide library.

“Administrator-oriented” chapters:

- Chapter 5 — Administrator-level setup features.
- Chapter 6 — Transferring survey files to a computer.
- Chapter 7 — Troubleshooting and error messages.
- Chapter 8 — Using the Detective-EX with a computer and ORTEC spectroscopy software.

- Chapter 9 — Specifications.
- Chapter 10 — Changing the internal battery.
- Chapter 11 — Calibration source statement.

1.4. Spectrum and Search File Storage, Transfer, and Viewing

The Detective-EX can store a nearly unlimited number of Identification Mode spectra in the ORTEC **.SPC** file format, ANSI N42.42 format, or both. Search Mode count-rate “strip charts” can be saved in the ORTEC **.CHN** format. The background file is in the **.CHN** format. See Section 1.4.2 for more information on file types and filenaming conventions. For details on saving and viewing Identification Mode spectra and the associated reports, see Section 5.1.6.

The files can be stored on user-supplied, removable Secure-Digital (SD) memory cards,⁵ or in the computer’s **My Documents** folder. The number of spectra stored on an SD card depends on the card’s capacity. For SD cards, the **DetectiveEX** program automatically creates a **Data** folder in which spectrum and search files will be stored. If the card fills to capacity, the Detective will automatically begin storing spectra in its computer’s **My Documents** folder.

The **background.chn** file is stored on the computer in the **\Program Files\DetectiveEX** folder. If it is moved or deleted, you must perform a new background measurement before using the instrument for radionuclide identification.

If you store the spectrum files on SD cards, they can be transferred directly to your computer with an SD card reader and Windows Explorer. Alternatively, files stored on SD card or in the computer’s **My Documents** folder can be downloaded via the USB port to any computer running under Windows 8 or 7 via the Windows Mobile Device Center, or Windows XP Professional SP3 via Active-Sync®. See Chapter 6 for detailed instructions.

IMPORTANT *Before connecting the Detective-EX to a computer for the first time, install ActiveSync or Windows Mobile Device Center **first**. Otherwise, the Detective-EX may not be able to communicate properly with the computer. Be sure to read Chapter 6.*

The accompanying MAESTRO® MCA Emulator Software (A65-BW) can be used to view the search and identification spectrum files from the Detective-EX. MAESTRO can also be used to operate the Detective-EX as a standard multichannel buffer (MCB) and store the resulting spectra to disk as ORTEC spectrum files. For more information on these operations, see Chapter 8.

⁵Note that the computer also has a CF type II CompactFlash slot. However, the dust cover — which must be in place to prevent contaminating the card slots — blocks full insertion of the CF card.

1.4.1. Saving Spectra and Searches

The current Identification Mode spectrum or Search Mode “strip chart” is stored in the unit's spectrum memory. If you do not save this spectrum or search, it will be lost when you begin the next data acquisition.

To save the current gamma-ray spectrum or search strip chart in stored-spectrum memory, tap the **Save** button.

The **Spectra** dialog allows you to select the sample description options, and file formats and storage location; and view the contents of the stored-spectrum memory. See also Section 5.3.3.

1.4.2. File Formats and Filenaming Conventions

1.4.2.1. Identification Mode Spectra

These can be saved on the ID Mode and (spectrum) Display screens. You can choose to store them in either the ORTEC .SPC file format; in ANSI N42.42 format, which is compatible with the ANSI N42.42-2006 standard; or both.

The .SPC file contains three parameters in addition to the contents specified in the *ORTEC Software File Structure Manual for DOS and Windows Systems* (Part No. 753800; hereinafter called the *File Structure Manual*):

- Total neutron counts for each acquisition (zero for Detective-DX/DX-100®).
- The neutron count rate at the time the spectrum file is saved (zero for Detective-DX/DX-100).
- A “normal” or “100” entry that indicates whether the spectrum was collected using a standard Detective-EX/DX or a Detective-EX/DX-100.

The ANSI .N42 file is formatted for an InstrumentType of **RadionuclideIdentifier**. It includes the spectrum, calibration, sample description, and identification results; neutron count rate (if the unit is so equipped); and GPS location log (if so equipped).

The filename format of the identification spectrum is:

YYYY_MM_DD_hh_mm_sss

1.4.2.2. Search Mode “Strip Charts”

Search Mode data are “strip charts” of count rate vs. elapsed time. These can be stored in the ORTEC **.CHN** format; or in ANSI N42.42 format, formatted for an InstrumentType of **PersonalRadiationDetector**.

The **.CHN** format is simpler than the **.SPC** format, and is described in the *File Structure Manual*.

The **.N42** file includes the sample description and a count rate log for the gamma strip chart; the count rate log for the neutron strip chart (if the unit is so equipped); and GPS location log (if so equipped).

The format filename of the search files is:

YYYY_MM_DD_HH_MM_SS**type**

When saving in the ORTEC **.CHN** format, two files are saved for each search, one for the gamma count and one for the neutron count; **type** is either **G** for the gamma-ray chart or **N** for the neutron chart.

When saving in ANSI **.N42** format, only one file is generated; **type** is **B** indicating that it contains both the gamma-ray chart and (for units so equipped) the neutron chart.

1.4.2.3. The Background File

The background file is saved in the Computer’s **\Program Files\DetectiveEX** folder as **background.chn**, and is overwritten each time the background is updated.

1.5. A Note About the DX and DX-100 User Interface

The illustrations and text in this manual reflect the user interface for the Detective-EX and EX-100T models, which have neutron detectors. Note that because the DX/DX-100 do not have neutron detectors, the user interface does not display neutron count-rate meters, dose alarm controls, search controls, property pages, etc.

1.6. The “Launcher” Interface for Multiple Identifier Applications

ORTEC supports our versatile Detective/trans-SPEC platform with a wide range of nuclide identification applications. When only one identifier application is installed on your instrument, it automatically starts up that application each time the unit is rebooted. If subsequent ORTEC applications are added to your instrument, our “Launcher” interface (Fig. 2) runs first, making it easy to switch between ORTEC identifier programs and exit to Windows Mobile. Simply tap the desired program.⁶

If you wish to specify one of the applications to auto-start when the Detective-EX is rebooted, just mark the checkbox beside the desired application.

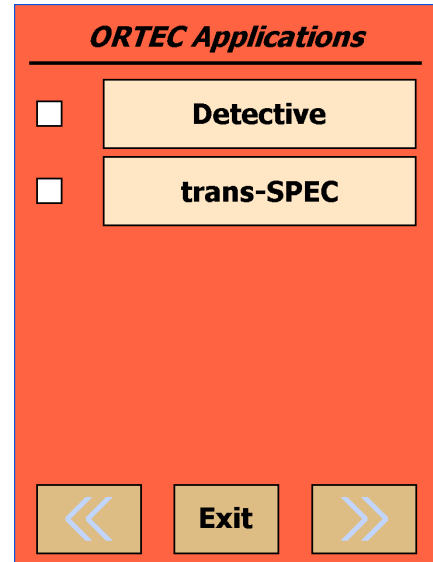

Figure 2. The Launcher Screen.

Figure 2 illustrates the Launcher screen for a Detective-EX on which the **trans-SPEC** program is also installed. Note that neither application is marked for auto-start. In this configuration, the Launcher screen is displayed after each reboot. If more than four applications are installed, the Launcher displays multiple pages; tap the scroll/paging indicator as needed.

IMPORTANT *If you use the trans-SPEC program to change any of the hardware settings, restarting the Detective program will return the identifier to all Detective factory calibration, gain, and rise-time settings, ensuring the instrument will operate as described in the rest of this manual.*

⁶If, on reboot, the Microsoft® Windows® Mobile desktop is displayed instead of the Launcher or a spectroscopy application, tap **Start** then **Launcher**. Alternatively, you can bypass the Launcher and start either program by tapping **Start**, **Programs**, and the application name.

2. THE DETECTIVE-EX/DX-100T

This chapter covers the steps you will need to prepare the Detective-EX for use:

- Unpacking, setup, and hardware overview (Sections 2.1 through 2.6)
- Operating cautions (Section 2.7)
- Startup and cooldown (Section 2.8)
- User-interface basics (Section 2.9)
- Choosing the spectrum file format(s) and file storage location (see Sections 5.3.3.3 and 5.3.3.4 on page 67)
- Initial calibration check (Section 2.11) and background measurement (Section 2.12)

Note also that where the spectrum should not be viewed by the operator, the spectrum display can be disabled (see Section 5.2.4.2).

2.1. Unpacking and Setup

When you receive the Detective-EX/DX-100T, the shipping box contains the following:⁷

- The Detective-EX/DX-100T portable identifier and USB cable
- The *User's Manual* (P/N 931040)
- Padded carrying strap
- Docking station or ac power adapter/charger with optional built-in ¹³⁷Cs source⁸
- Disposable plastic instrument covers (P/N 932725)
- An automobile accessory adapter to power the docking station or PAC-II charger from a 12 V battery
- An automobile accessory adapter to power the trans-SPEC-DX-100 directly from a 12 V battery

NOTE If your Detective-EX was shipped in a foam-lined box, instead of a high-impact plastic case, be sure to keep the box and foam and use it for shipping the identifier.

Any options will be packaged separately, and will include instructions for that option.

⁷Subject to change without notice.

⁸The identifier is factory pre-calibrated using a multi-nuclide source. The calibration can be updated using a only small ¹³⁷Cs source. The instrument is usually supplied with an exempt-quantity ¹³⁷Cs source, with a nominal activity of 1.0 μ Ci (37 kBq), built into the docking station source tower. If your unit was not supplied with a ¹³⁷Cs source, you can use naturally occurring ⁴⁰K or else define other calibration sources, as described in Section 5.2.1.

2.2. The Detective-EX/DX-100T

Figure 3 shows the Detective-EX/DX-100T's features.

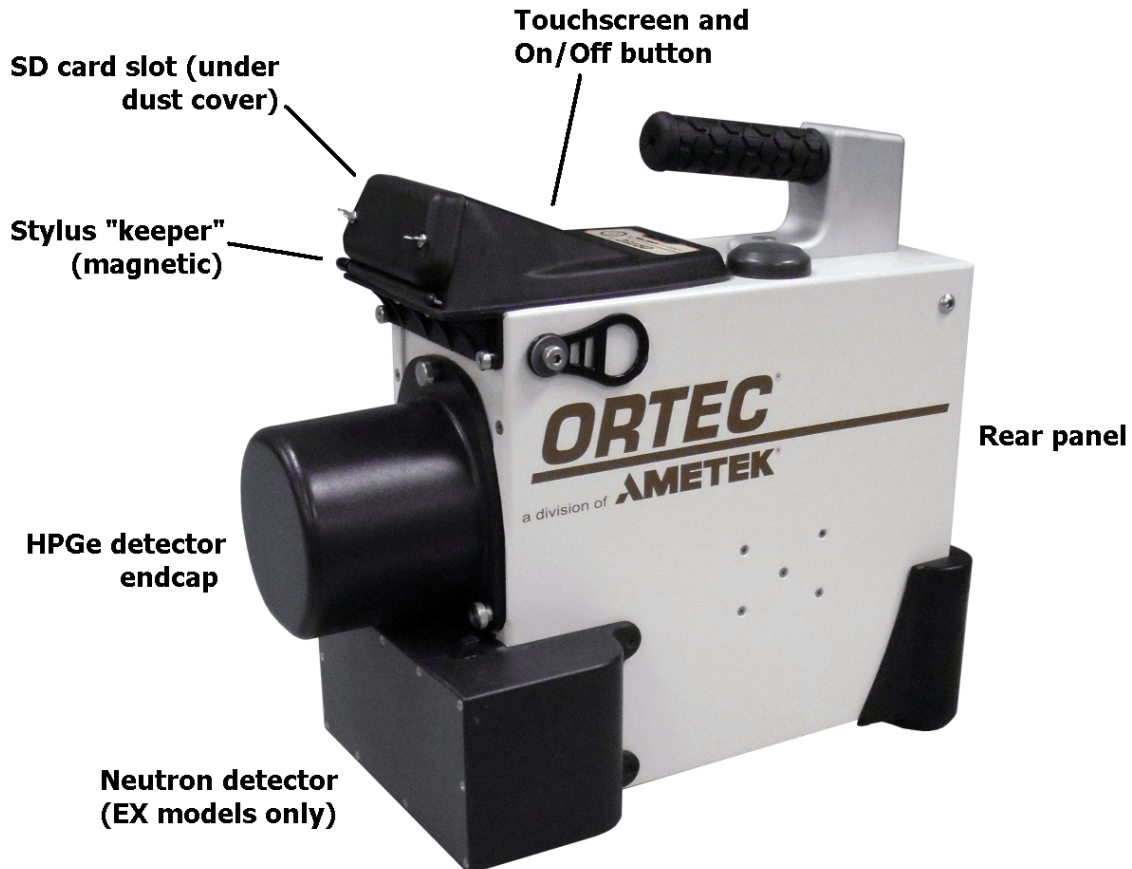

Figure 3. Detective-EX/DX-100T Features.

2.2.1. Front Panel

- **ON/OFF Button** Located below the touchscreen, on the base of the bezel. To reboot the computer, press the power button. The computer will restart, then automatically launch the unit's software application (the cooler will stay on throughout).
- **SD Card Slot** This is located on the front panel under the protective dust cover. To release the cover, press and rotate by a quarter turn the two captured, bayonet-mount screws. The SD slot is keyed so the memory card can only be inserted in one orientation. Insert the card and close the protective cover.

NOTE *We strongly recommend that the dust cover be fastened in place at all times to protect the card slots from moisture and particulates.*

Figures 4 and 5 show the PAC-II charger, and the docking station, respectively. The hardware specifications are in Chapter 9. Place the Detective-EX on the docking station or beside the PAC-II.



Figure 4. PAC-II Charger, Front and Rear Panels.



Figure 5. Docking Station.

2.2.2. Rear-Panel Connectors

Figure 6 shows the Detective-EX rear-panel, including the three connectors:

- **INPUT POWER** — Supplies external power for operating the instrument and recharging the internal battery.
- **DATA** — USB connector used to connect the unit to a computer to transfer stored spectra.
- **CONTROL** — USB port connects the Detective-EX's MCA board to a computer for use as an HPGe spectrometer with MAESTRO. Stored spectra cannot be downloaded from this port.
- Headphone jack (🎧) — For dose and count rate warning sounds. The headphone volume can be adjusted as described in Section 5.2.8.

Each connector includes a dust cover.

NOTE *We strongly recommend that the dust cover be fastened in place at all times to protect the card slots from moisture and particulates.*

2.2.3. The Touchscreen

Figure 7 shows the user interface on the Detective-EX's high-resolution color touchscreen, which makes it easy to view data acquisition and settings, as well as change the instrument settings.

To select a function, tap it with your finger or a stylus (*pens, pencils, and other objects will scratch the touch-screen and should not be used*). In fields where alphanumeric input is needed, tap to open the “soft keyboard” at the bottom of the screen (see Fig. 56 on page 57).

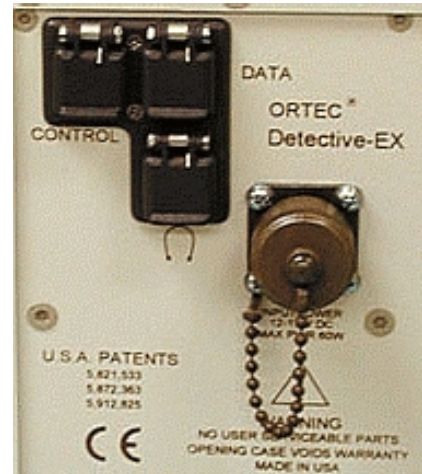

Figure 6. The Detective-EX-100T Rear Panel.

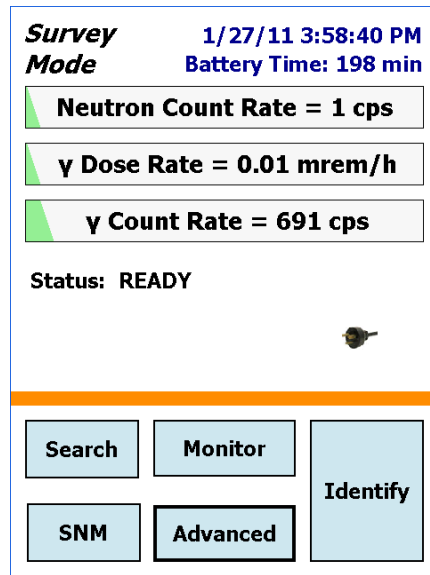

Figure 7. The User Interface.

2.2.4. Attaching the Carrying Strap

The carrying strap (Fig. 8) should be installed on the top-diagonal corners of the Detective-EX; that is, looking down on the display panel, the strap should be anchored to the left-front and right-rear corners or vice versa. If you wish to change the factory orientation, use a 5/32-in. hex wrench to exchange positions of the strap-hanger studs and the regular hex-head screws. Thread the strap-hanger stud through the hanger bracket, followed by the two spacers, then insert the stud into the Detective-EX and tighten until the hanger bracket resists rotation but still turns (*do not overtighten*).

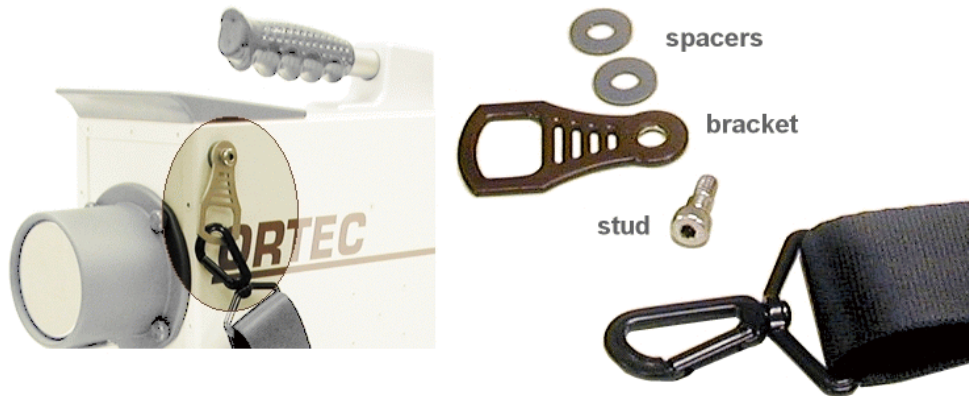

Figure 8. Carrying Strap Attachment.

2.3. The Docking Station

The docking station houses both the charger for the Detective-EX's internal lithium-ion battery, and two low-noise fans that assist heat exchange in the Detective-EX. In addition, a sealed ^{137}Cs calibration source, with an activity of $\sim 1 \mu\text{Ci}$ (37 kBq), is mounted in the top of the docking station's source holder on the front of the docking station, for use with the auto-calibration feature (see Section 2.11). Figure 9 shows the connector, cable, and indicators on the docking station's front panel. Figure 10 shows the rear panel and ac power supply.



Figure 9. Docking Station Front Panel and Battery Charger Cable.



Figure 10. Docking Station Rear Panel and AC/DC Power Adapter.

Place the docking station on a hard, level surface. The underside of the docking station should be kept clear so air can circulate to help dissipate the heat from the cooler. For more information on proper placement and treatment of the docking station, see the setup instructions in Section 2.8.1 and the cautions in Section 2.7.

2.3.1. Connectors and Indicators

In addition to the built-in calibration source, the docking station features:

- Integral front-panel external power and battery charger cable that attaches to the Detective-EX INPUT POWER connector.
- Front-panel red and green CHARGE STATUS indicators. While the Detective-EX's internal battery is charging, the red indicator is continuously lit. When the battery is fully charged, the green indicator turns on and the red indicator turns off.
- Rear-panel dc POWER IN connector attaches to the ac/dc power adapter or other 12 V power source.

2.3.2. Strapping the Detective-EX to the Docking Station

Use the supplied black nylon strap to hold the Detective-EX and docking station together, if desired. Thread the strap through the silver brackets on the left and right sides of the docking station, and under the handle of the Detective-EX, as shown on the left side of Fig. 11. Thread the end of the strap through the buckle as shown on the right side of the illustration, and tighten.

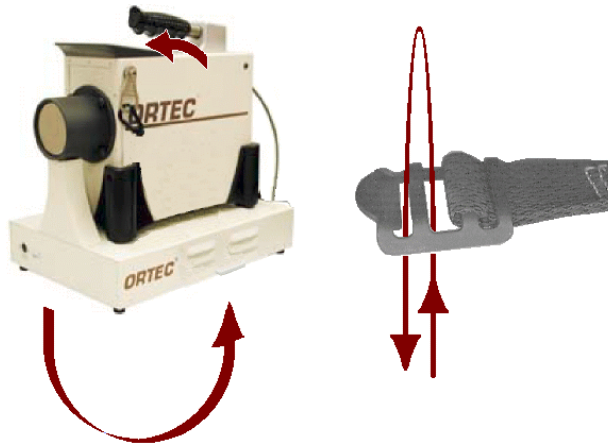

Figure 11. Strapping the Detective-EX and Docking Station Together.

2.4. The PAC-II Charger

The PAC-II power adapter/charger is more compact than the docking station, and can charge the Detective-EX's internal battery using either ac mains or 12 V dc power. The circuitry automatically determines whether the charger is connected to an ac or dc source. The PAC-II does not contain a calibration source nor is it designed to dissipate heat from the Detective-EX. Figure 4 on page 11 shows the front-panel charging indicators and output cable; and the rear-panel ac and dc power supply connectors.

Place the PAC-II on a hard, level surface where air can adequately circulate around it. For more information on proper placement and treatment of the docking station or PAC-II, see the setup instructions in Section 2.8.1 and the cautions in Section 2.7.

To use the PAC-II, attach its OUTPUT cable to the Detective-EX INPUT POWER connector, then connect either the ac or dc power cord (both supplied) to the appropriate rear-panel connector. While the Detective-EX's internal battery is charging, the red LED on the PAC-II front panel is continuously lit. The red indicator flashes if you disconnect the Detector before its battery is fully charged, or if the Detective-EX is connected but the internal battery is faulty. When the battery is fully charged, the green LED turns on and the red LED turns off.

2.5. The Automobile Accessory Adapter

The Detective-EX is supplied with two automobile accessory adapters for use with a 12 V battery. One attaches to the POWER IN connector on either the docking station or the PAC-II, both operating the Detective-EX and charging its internal battery. The other attaches to the Detective-EX's rear-panel INPUT POWER connector and operates the Detective-EX but does not charge the internal battery.

NOTE If the detector is warm, the power required to cool the detector can significantly discharge a standard automobile battery.

To use an adapter cable:

- Plug the adapter end into a 12-V auto-mobile accessory socket.
- Connect the cable to the appropriate connector. If using the adapter cable that connects to the docking station or PAC-II, plug it into the charger base's POWER IN connector. The internal battery will begin charging; if completely discharged, it will typically reach full charge in 3–4 hours.

If using the adapter cable that connects directly to the Detective-EX, unscrew the dust cap from the INPUT POWER connector on the rear panel; slide the coupling ring on the male (cable-end) connector fully open; align the 5 keys on the male connector with the slots on the rear-panel female connector; press to fully seat the male connector, then hold it in place; and rotate the coupling ring approximately 1/8th of a turn clockwise until it seats securely.

2.6. Internal and External Power

The Detective-EX uses power in these ways:

- The internal battery provides approximately 3 hours of operation. The internal battery cannot be used to start the cooler or cool the detector from room-temperature; *external power is required*. The transition from internal to external power is automatic and does not interfere with data collection. Cooler startup without external power cause operational anomalies; these are discussed in troubleshooting Sections 7.5 and 7.6. An exhausted internal battery should be charged for 2 hours before the Detective-EX is cooled using external power.

- The docking station or PAC-II provides external power to simultaneously start and operate the Detective-EX, as well as charge the internal battery. In addition, the docking station fans help dissipate heat from the cooler. Both charger bases can be powered from mains or a 12 V source.
- Other external power (supplied by external battery belt or 12 V automobile battery) can start, cool, and operate the Detective-EX, but does not charge the internal battery. The internal battery is charged only if the external source also powers the docking station or PAC-II. If extended remote operate is needed, use the external battery first, then the internal battery.

The icon on the right side of the screen above the buttons (Fig. 12) shows the current type of power connection. These are, clockwise from upper left: (1) internal battery, (2) unit properly connected to the docking station or power adapter/charger, (3) external power to operate unit, and (4) battery charging.



Figure 12. Power Source Icons.

2.6.1. A Note on Internal vs External Battery Power

The recharging circuit for the internal battery is separate from external power so the external batteries are not consumed charging the internal battery. The internal battery is only recharged through the use of a special lithium-ion battery charger unit built into the docking station and PAC-II using connections in the multi-pin power plug. The charging base will simultaneously supply both “external power” and connect to the battery charger to recharge the internal battery.

When connected to an external battery, the Detective-EX relies on external power until the external voltage drops below 9 V. It then switches to the internal battery. The instrument makes the transition smoothly, and there is no effect on the energy resolution. If you begin with both batteries fully charged, the sum of the two battery capacities will be achieved. If the external battery has its own charge indicator, this can be used to determine when the changeover will occur. The Detective-EX battery monitor indicates the available capacity in the internal battery, and when the switch over occurs, this indicator runs down in the usual manner.

NOTE When all power is exhausted, the high voltage and cooler will shut down and the detector will begin to warm. The Detective-EX cannot be used again until the unit has cooled enough that the high voltage automatically switches on and the Status indicator says **READY**.

2.6.2. Replacing the Internal Battery

The internal battery typically lasts 3–5 years. See Chapter 10 for instructions on replacing it. Note that the battery hatch is the only part of the Detective-EX case that can be opened without voiding the warranty.

2.7. Operating Cautions and Notes

- Remember that there are no user-serviceable parts inside the Detective-EX. Opening the housing (except the battery hatch to replace the internal battery) voids the warranty.
- The cooler and detector are shock-sensitive, with a maximum tolerance of 20 g, so be careful not to drop the Detective-EX. A shock in excess of this value will void the warranty.
- The Detective-EX is splash-resistant, but not watertight. To avoid equipment failure, protect it from prolonged or heavy rainfall and from immersion. Heat is dissipated from the cooler via the Detective-EX baseplate; therefore, do not place the instrument in mud, loose soil or sand, standing water, dense grass; or on thick carpet. Wrap or cover the unit to keep it clean and dry. Where possible, avoid placing it on warm surfaces, such as sun-heated pavement, for extended periods. The front-panel memory card slots and rear panel connectors include dust caps; *keep the card slots and all unused connectors capped.*
- The docking station and PAC-II contain a portion of the battery-recharging system and should not be exposed to water. When using the docking station, be sure to keep the underside clear of obstructions so the fans can function properly. Both charger bases should ideally be placed on a dry, flat, level, and dust-free surface. When not in use, the charger base can be disconnected from the ac power supply, then covered to protect it from moisture and dirt. Any covering must be completely removed before reconnecting the docking station to either charger base to the input power source. Make sure the recharging connector on both the Detective-EX and charger base are clean and dry before connecting to an the input power supply.
- The Detective-EX is designed for use at temperatures between 0 and +40°C and at a relative humidity of <90% at 35°C, non-condensing.
- The HPGe detector assembly is designed to be continuously cooled. If the instrument is turned off and allowed to warm between uses, it must be cooled and brought to operational status (**Status: Ready**) for *at least 48 hours every month*. Failure to do this may result in degraded performance or cooling system failure. Read Section 9.7.

- To avoid damaging the cooler (and, where applicable, to comply with transportation regulations), be sure to turn the cooler off before shipping the Detective-EX (see Section 2.8.2). The unit can be shipped as soon as the cooler is turned off; there is no need to wait until the detector warms up.
- For best results, we recommend that you not allow the instrument's internal battery to become exhausted, and that you read Section 2.6 on the Detective-EX's internal and external power sources.
- When monitoring very high-activity sources (whether the source is an innocent or threat nuclide), ***if the detector Dead Time exceeds 70%, the detector cannot process gamma radiation and generate IDs according to its performance specifications.*** A red indicator in the upper right corner of the screen tells you to ***MOVE BACK*** from the source until the dead time drops below 70% so the instrument can perform as specified. See Fig. 15 (page 22) and its associated discussion.
- When the most recent background reading is no longer valid, the **Background Invalid** message is displayed on the Survey Mode screen. The Identify and Monitor buttons become inactive and the system will not post radionuclide IDs until a new background is accepted (see Section 2.12). However, the gamma and neutron count-rate meters on the Survey, Search, and SNM Mode screens continue to function normally, so the unit is still passively monitors.

2.8. Startup and Cooldown

Before using the Detective-EX, you must:

- Connect it to the power adapter/charger or other external power source. This will boot up the computer, start the cooler, and start the **DetectiveEX** software application at the Survey Mode screen.
- Wait for the detector to cool down to operating temperature. Typically, this takes <12 hours for the Detective-EX.
- Depending on your power source options, charge the internal battery for 3–4 hours.
- Check the detector calibration.
- Set the data storage location.

This section will help you prepare the Detective-EX for use as quickly as possible. Therefore, some of the steps are not explained in detail; however, references to additional information are provided.

2.8.1. Connecting the Detective-EX to the Charger Base and Powering It On

The first startup step is to connect the Detective-EX to its docking station or power adapter/charger to power the cooler and begin charging the internal lithium-ion battery.

- Place the charger base on a hard, level surface. If using the docking station, its underside must be kept clear so air can circulate to help dissipate heat from the cooler. See the cautions in Section 2.7 (page 18).
- AC — Connect the charger base's output cable to the front-panel POWER IN connector, then connect the mains power adapter cord to mains power.
or
DC — Connect the dc power cord to the front-panel POWER IN connector, then to a suitable dc power source.
- Place the Detective-EX on the docking station or beside the PAC-II, and attach the charger base's output cable to the Detective-EX INPUT POWER connector. To attach the cable to the Detective-EX, unscrew the dust cap from the INPUT POWER connector on the Detective-EX's rear panel; slide the coupling ring on the male (cable-end) connector fully open; align the 5 keys on the male connector with the slots on the rear-panel female connector; press to fully seat the male connector, then hold it in place; and rotate the coupling ring approximately 1/8th of a turn clockwise until it seats securely. The internal battery will begin charging and will typically reach full charge in 3–4 hours (well before the detector has cooled to operating temperature range).
- As soon as power is applied, the computer will automatically begin its boot-up sequence, and within 20–40 seconds the cooler will start running. After the computer initializes, the [DetectiveEX](#) software application will start up in Survey Mode. As noted above, the internal battery will not charge until the detector is cooled to operating temperature. After that, the battery will typically reach full charge in 3–4 hours. If the cooler does not start by itself, see the next section.
- Note the **Status** indicator on the display. On startup (Fig. 13), it will read:

Status: Detector is Warm

- When the battery is fully charged, the battery monitor will change to show the battery time remaining.

2.8.2. Turning On the Mechanical Cooler

The mechanical cooler should automatically turn on when the power is applied to the unit. You may be able to hear it and/or feel its vibration. If not:

- Tap the **Advanced** button to display the first Advanced Setup menu page (see Fig. 38, page 47).
- If the cooler is on, the upper-right menu button will be labeled **Turn Cooler OFF**. If it is labeled **Turn Cooler ON**, tap it to power up the cooler.
- Tap **Back** to return to the **Survey Mode**.

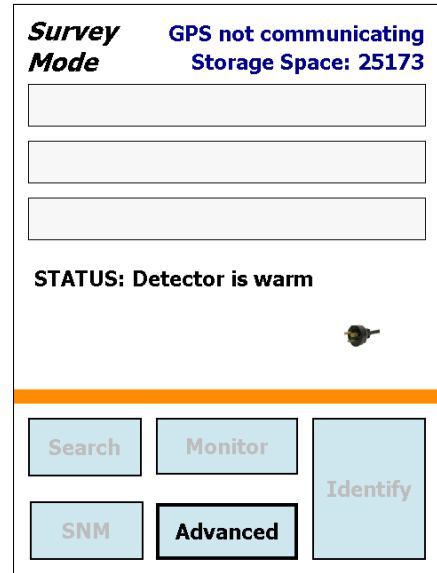

Figure 13. The Display at Startup.

The Detective-EX’s internal battery does not have enough power to cool down the detector from room temperature, so external power is required for cooldown. If you are using a standard automobile battery as the external power source, note that detector cooling can significantly discharge the battery.

A warm Detective-EX typically requires approximately 12 hours to cool to operating temperature.

When the detector reaches operating temperature, the Detective-EX bias voltage will automatically turn on. To see if the bias voltage status is **On** or **Off**, tap on **Advanced**, then **Status**. Until the detector has cooled and the HV has automatically turned on, **Detector Temp**, **Cold Tip Temp**, and **HV Volt** should read **ERR**, then switch to **OK**. At this point, the status indicator on the Survey Mode screen will show **Ready**.

NOTE You can turn the cooler off for a brief period (e.g., 10 to 20 minutes) without significantly warming the detector. As soon as the cooler is restarted, the Detective-EX typically shows a **Ready** status within a few seconds. In addition, the cooler can be restarted at any time, without harming the detector crystal, regardless of whether the detector is warm, partially cooled, or cooled to the operating temperature range.

2.9. The User Interface

2.9.1. Instrument Status Indicators

- **Date/Time, GPS Location, Dead Time, Battery Status, and Storage Space** — The top line in the upper right corner alternates between the date/time, latitude/longitude, and detector dead time. The lower line switches between from the battery status (charging vs. time to full discharge) and the number of spectra that can be stored in the currently selected storage location. See Fig. 14.
- When close to “hot” gamma-ray sources, the HPGe detector can become so busy processing radiation pulses that its analysis algorithm does not function as designed and specified. To avoid this problem, when the detector *dead (busy) time* >70%, a red warning message is displayed in the upper right corner of the screen (Fig. 15), and persists until you move away from the hot source.

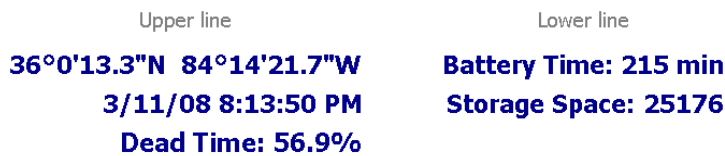

Figure 14. Alternating Status Indicator Displays.



Figure 15. Too Close to High-Activity Source.

- **Instrument Status Area** — The center of the Survey Mode screen provides brief indicators of the unit’s readiness for data acquisition. The Status is either **READY** (Fig. 23) or **Detector is warm**. In addition, warnings such as the high gamma dose rate message are posted in this part of the screen.
- **Power Source Indicator** — The four power source icons are shown in Fig. 16. Clockwise from upper left: (1) operating on internal battery, (2) unit properly connected to the power adapter/charger, (3) operating on external power, and (4) battery charging.



Figure 16. Power Source Icons.

2.9.2. Moving Through the Menus

To move through the dialogs, tap the soft buttons shown on the display. The functions available are shown on the buttons. If a function you want is not shown, it is not available from this dialog. In some cases the function has been disabled in the Advanced Setup.

- To select a function on a dialog, tap on the button.

- To return to the preceding dialog, tap **Back**. For example, tapping **Back** from the Advanced Setup dialog (Fig. 17 on page 24) returns you to the Survey Mode screen (Fig. 23).
- On any entry, if you just tap **Back** without tapping any other keys, the current value will be used; that is, no change will be made. Therefore, if you open a dialog by mistake, you can just tap **Back** to return to the previous screen without changing any values.
- If a text or number entry is needed, a soft keyboard will be displayed at the bottom of the screen. Tap on the letters or numbers desired and then tap **OK**.
- The Identification, Search, and Display screens have a **Save** button. In Identification Mode, this saves the current energy histogram (spectrum) in memory and identification results. In Search Mode, a histogram of counts vs time is saved. The storage location is selected on the **Spectra** screen (Section 5.3.3.3). The Spectra screen also includes an **Ask for Sample Description** option that allows you to enter a description of this data acquisition.

2.10. Selecting the Data Storage Location and File Formats

This is discussed in Sections 5.3.3.3 and 5.3.3.4 (page 67).

2.11. Checking the Calibration

Once the Detective-EX is **Ready**, the next setup step is to check the calibration. This procedure checks and adjusts the Detective-EX's electronics so that it correctly identifies the nuclides in the area. For an application as important as interdiction of illicit nuclear materials trafficking, it is important to know that the nuclide identification is correct. Routine use of the recalibration feature is a solid means of quality assurance, which can be used to support legal proceedings.

The Detective-EX is shipped pre-calibrated, but we strongly recommend the calibration be checked before first use, then rechecked periodically. The digital electronics are extremely stable, and in most situations are unlikely to need recalibration except at long intervals: days or weeks. However, if wide ranges of ambient temperature variation are experienced (say, a change of 20°C), we recommend checking the calibration more often.

NOTE Before using the **Calibrate** feature, the calibration source must be selected on the **Cal. Settings** dialog under the Advanced Settings. The Detective-EX allows you to select from two predefined calibration sources, ^{137}Cs or ^{40}K ; or define two of your own sources. See Sections 5.2.1 and 5.1.3.

If the docking station is not available or if you are using the PAC-II, a small calibration source can be used in conjunction with the manual calibration check to ensure the unit remains in calibration.

To perform the manual calibration check:

- On the Survey Mode screen, tap on **Advanced** (see Fig. 17), then **Calibrate**.
- Position the indicated source (in this case, ⁶⁰Co) in front of the detector window, then tap the **Start Calibration Now** (Fig. 18) button.
- While calibration is in progress (Fig. 19), the unit will show the **Time remaining**. This interval will depend on the strength of your calibration source.
- At the end of the calibration period, the **Use Improved Calibration** button will be displayed, along with the calibration and peak-shape indicators for the new measurement (Fig. 20).

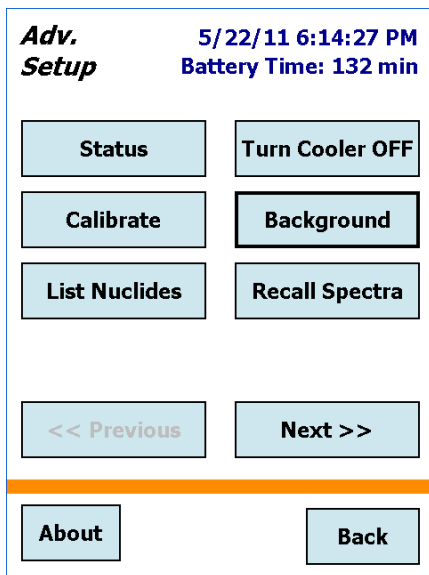

Figure 17. On the Advanced Menu, Tap the Calibrate Button.

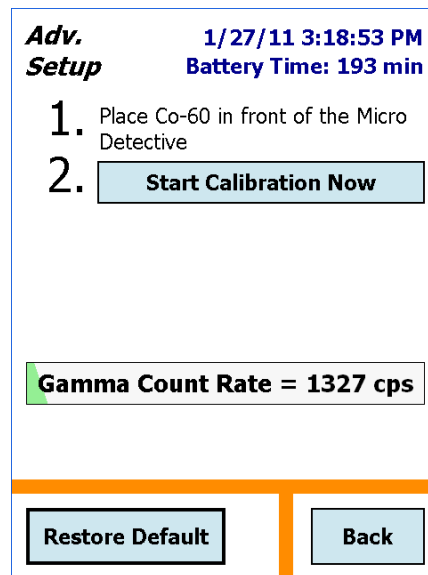

Figure 18. Tap the “Start Calibration Now” Button.

The choice is yours whether to use this new calibration or not. To accept it, tap **Use Improved Calibration**. Usually, the proposed change in calibration is of the order of the one shown in Fig. 20. If it is larger than 0.3%, the cause should be investigated (see Section 7.8).

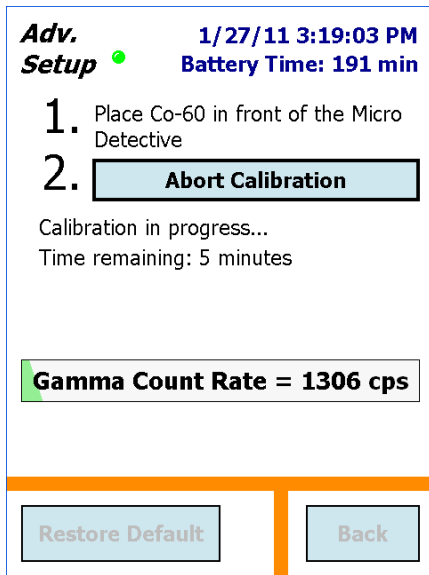

Figure 19. Status of Manual Calibration.

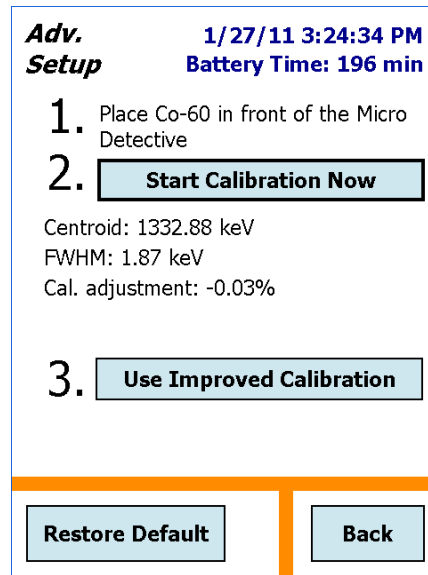

Figure 20. Apply New Calibration Selection.

- The final step is to take a representative background measurement. Figure 21 shows the final calibration screen. Remove the calibration source, tap the **Run a Background** button, then refer to Section 2.12 below.

NOTE A new background measurement is *required* after calibration. If you tap **Back** without accepting the new background, only the gamma and neutron count-rate meters will function; Identify and Monitor Modes will be disabled until another you run and accept a new background.

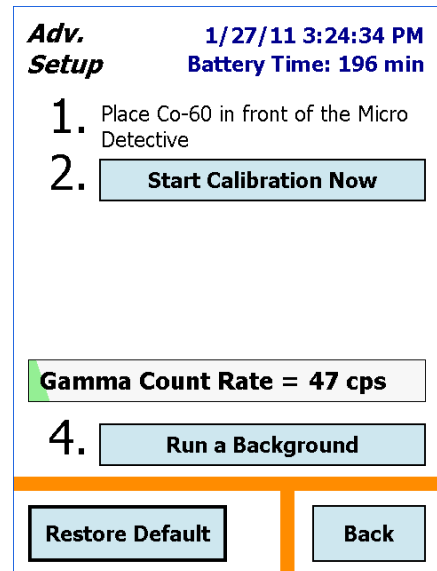

Figure 21. Run a New Background.

For more information on calibration, see Sections 5.2.1 and 5.1.3.

2.12. Running A New Background After Calibration

The manual calibration routine deletes the current `background.chn` file. Therefore, the final step of manual calibration is to run a new background.

NOTE *This section discusses only the mandatory background measurement required to complete the manual calibration.* For the full discussion of Detective-EX background measurements, see Section 5.2.2. As noted elsewhere, until you complete the background measurement, the Identify and Monitor Modes will be disabled.

The minimum acceptable data collection time for the background meas is set on the **Bkg Settings** screen (see Fig. 61 on page 60). Note that, for optimum counting statistics, we recommend a minimum 30-minute background acquisition. However, the background settings screen also allows minimum intervals of 1, 5, or 15 minutes.

- All sources should be removed from the area before you tap the **Run a Background** button at the end of the manual calibration routine. If you leave the source in place, a “high count rate” message will remind you to remove the source and restart the calibration.
- Tapping the **Run a Background** button opens the screen shown in Fig. 22 and automatically starts the background acquisition.
- Acquisition continues until you tap either **Save** or **Cancel**, which returns you to the **Advanced** menu. *If the measurement is canceled before that minimum time has elapsed, the software does not accept (i.e., save and use) the new background spectrum.*
- If necessary, you can obtain a valid background later. See the instructions in Section 5.2.2.

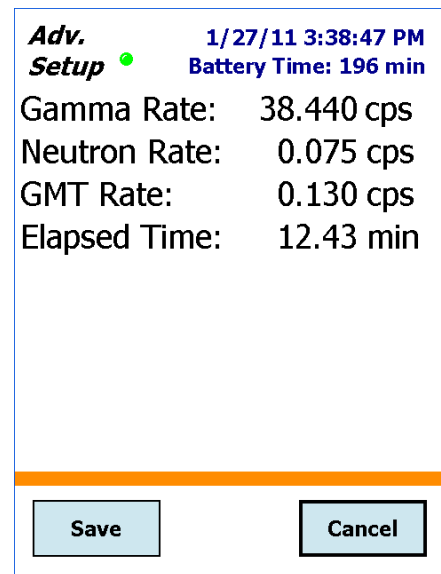

Figure 22. Collect Background for At Least the Specified Minimum Time.

2.13. Optional: Restricting Access to the Advanced Settings

A password can be set to restrict access to the second and third pages of the Advanced Setup menu; see Section 5.2.4.1 for instructions.

NOTE Passwords are *case-sensitive* and can include “space” characters. *Note that there is no master password so be sure to record it.* If you lose the password, you must contact your ORTEC representative or our Global Service Center for assistance.

***** *The Detective-EX is now ready to use* *****

[Intentionally blank]

3. RADIATION MONITORING

Once the Detective-EX displays the **Ready** status, the calibration has been checked, and the background has been measured, the instrument is ready for use. This chapter tells you how to use the Survey, Identification, Search, Monitor, and SNM Modes.

Some users will find enough information in this chapter to begin using the Detective-EX right away — operation is very straightforward.

However, we also recommend the following reading:

- Chapter 4 lists the messages the Detective-EX displays when it identifies radionuclides.
- Chapter 5 discusses the functions on the **Advanced** menu. These administrator-level commands allow you to set up and adjust a number of detector functions, such as turning on the mechanical cooler, selecting the location where spectrum files will be stored, choosing the dose-rate units to be displayed, determining the frequency of auto-calibration, configuring the SNM search dwell time and quality factor, customizing the dose alarm sensitivity, and adjusting the “scroll rate” for the Search Mode strip-chart emulation.

IMPORTANT You can set a password to limit access to the second and third pages of the **Advanced** menu; see Section 5.2.4.1 for instructions.

- Chapter 6 provides instructions on downloading spectrum files to a computer.
- Chapter 8 gives detailed information on connecting the Detective-EX to a computer and using it as a high-performance benchtop multichannel buffer with MAESTRO or other ORTEC spectroscopy applications.

3.1. Survey (Count-Rate/Dose-Rate) Mode

In Survey Mode (Fig. 23), the Detective-EX behaves as a passive monitor, showing the current gamma count and dose rate; neutron count rate (for units so equipped); instrument status; detector dead time, available disk storage space and battery charge; time and date; and GPS coordinates.

The three rate indicators show the count rate or dose as both a value and a bar graph. The color of the bar changes with increasing rate. The lowest rate is green, then yellow, then red. The γ (gamma) **Count Rate** bar changes to yellow at ~6300 counts per second (cps), and red at ~13300 cps. At ~20,000 cps, the red bar begins flashing. These various states are illustrated in

Fig. 24. The factory-set alarm limits are 10000 μ Sv/h for the **Gamma Dose Rate** and 500 cps for the Neutron Count Rate bar. To set lower limits, see Section 5.2.7.

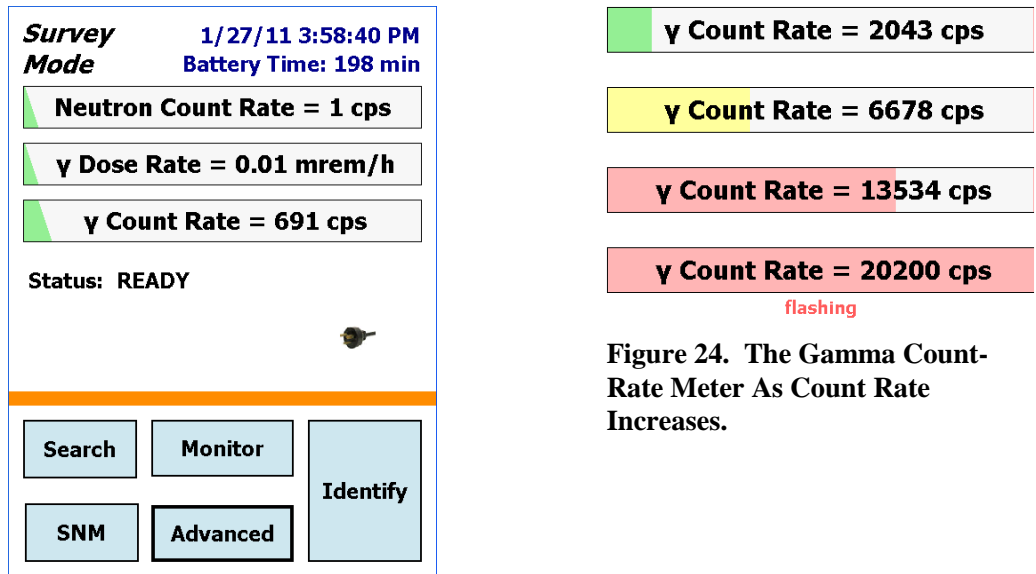

Figure 23. The Survey Mode Screen.

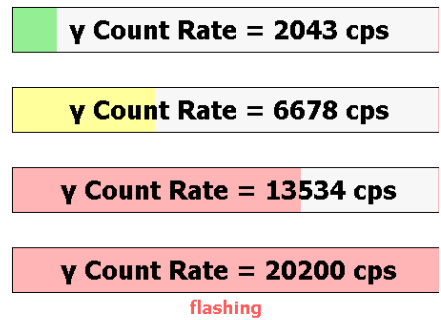

Figure 24. The Gamma Count-Rate Meter As Count Rate Increases.

When the gamma dose rate goes above the limit, the **WARNING!!! High Gamma Dose Rate!** message is displayed in the Instrument Status Area and an alarm sounds. You can optionally choose to set lower gamma dose rate and neutron count rate alarms using the Dose Alarm setup feature under the Advanced Settings screen (Section 5.2.7).

- Tap **Identify** to start the Identification Mode Section 3.2).
- Tap **Monitor** to start the Monitor Mode (Section 3.4).
- Tap **Search** to start the Search Mode (Section 3.3).
- Tap **SNM** to use the SNM Mode (Section 3.5).
- Tap **Advanced** to display the Advanced Setup dialog (Chapter 5).

NOTE If a blue simulated LED (●) is displayed in the upper left, beside the screen title, the instrument is in the LCX radiation detection mode, which we strongly recommend for use only by experienced gamma spectroscopists. Be sure to read Section 5.2.3.3 and/or refer to your organization’s operating procedures before using LCX Mode.

3.2. Identification Mode

The Identification Mode lists the radionuclides present; and displays them in one of two ways, according to the ID Display Mode selected on the **Identify** setup screen (Section 5.2.3.2).⁹

There are two ID Display Modes:

- **“ANSI” Mode** — This is the default mode. Radionuclide IDs are listed on a background color-coded according to their status as innocent (green), suspect (yellow; LCX Mode only), or threat (red). The color background can be suppressed (Section 5.2.3.4).
- **“Classify” Mode** — In this mode, the list of detected radionuclides are listed according to category instead of radionuclide name, e.g., **Medical, Industrial, Nuclear Plutonium, Other**.

Chapter 4 lists all nuclide IDs along with “ANSI” their threat/suspect/innocent status and “Classify” category.

Figures 25 and 26 compare the same four IDs as displayed in the “ANSI” and “Classify” modes, respectively. In each figure, the Detective-EX has found one industrial nuclide (unshielded ²⁴¹Am; innocent), and two uranium isotopes (²³⁵U and ²³⁸U; threats).

In addition, this screen allows you to:

- **Pause/Continue** the current identification measurement. This button has additional functions if you are counting to a real-time preset (see Section 3.2.2).
- **Save** the current spectrum and IDs (Section 3.2.3).
- On the “Classify” display, tap to display found-nuclide reports (Section 3.2.3).
- Tap **Intense** to display a continuously updating list of the 10 highest-confidence peaks currently being detected (Section 3.2.5).
- **Display** the real-time spectrum for the current data acquisition (Section 3.2.6). Note that if the spectrum view has been disabled on the Settings dialog (Section 5.2.4.2), the **Display** button is gray (inactive).

⁹The expert LCX Mode (Section 5.2.3.3) also displays *suspected* IDs, i.e., nuclides that have been tentatively identified at too low a confidence level to list them as definitively “found.”

- Switch to **Search** mode (Section 3.3). *If you do not **Save** the current spectrum and identification results data before going to Search Mode, these data will be lost.*

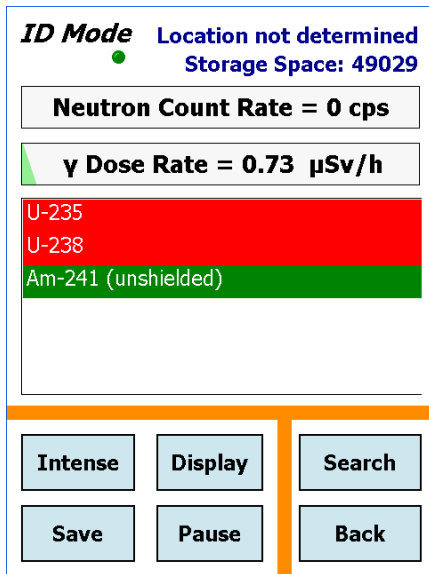

Figure 25. Identification Mode Screen in “ANSI” ID Display Mode.

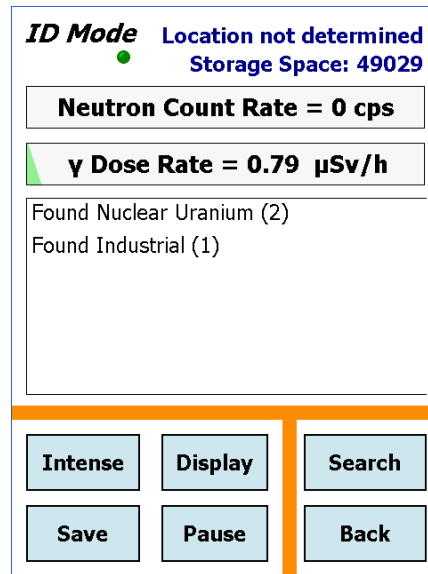

Figure 26. Identification Mode Screen in “Classify” ID Display Mode.

3.2.1. Start the Identification

To start an identification, tap the **Identify** button on any screen that displays it.

NOTE When you start an identification or switch to Search Mode, the contents of the live-spectrum memory are *erased* before the new data are collected. *If you wish to save the data from the most recent identification or search session, you must do so before starting the new identification session (tap **Save**).*

During data acquisition, a simulated green LED flashes at the top left of the screen. On units with GPS capability, the top right of the screen alternates between the elapsed acquisition time for the current spectrum and the GPS coordinates.¹⁰ In addition, the neutron count rate and the gamma dose rate continually update.

¹⁰If your GPS has not received signals from GPS satellites for >30 days (e.g., if it has not been in use or has been used continuously indoors), it may take 10–15 minutes for the unit to update and begin displaying location information.

At any time you can **Pause** the count and either **Save** the spectrum, return to the Survey Mode screen, or **Continue** counting.

If counting to a **Real Time Preset**, the elapsed time readout counts from zero to the preset (Fig. 27). Once the preset time has elapsed, the **Pause** button changes to **Continue**. At this point, you can either **Save** the spectrum or *extend the count* to add more data to the spectrum, as described in the next section.



Elapsed Time: 8
of 2000

Figure 27.

3.2.2. Extending the Count-to-Preset

To extend the count after the first preset count interval has lapsed — that is, to collect more data for this measurement — just tap the **Continue** button. The extended count will start, and the **Continue** button label will change back to **Pause**. Acquisition will resume, and will continue until you stop it by tapping **Back** (or by pausing again). The **Elapsed Time** readout at the top right of the screen will track the total count time.

NOTE Tapping **Pause** or **Continue** *does not clear the spectrum*. Pausing simply suspends data collection. When you continue, subsequent data are added to the existing spectrum until you tap **Back** to return to the Survey Mode screen. *The spectrum is retained in memory until you start the next identification or search acquisition*. If you have not already viewed and/or saved the spectrum, you can do so from the Survey Mode screen.

3.2.3. Save

Tap **Save** to write the current identification spectrum and results in the selected data storage location and file formats (Sections 5.3.3.3 and 5.3.3.4, respectively). You may save as many times as you wish, during acquisition or pauses, and after acquisition.

The results are saved in the spectrum file(s) and can be viewed both on the Detective-EX (Section 5.1.6) and with ORTEC spectroscopy applications such as MAESTRO. An identifying text description can also be entered if the **Ask for Sample Description** feature is enabled on the Spectra dialog (Fig. 74, page 66).

To end without creating a spectrum file, tap **Back**. This immediately returns you to the Survey Mode. The current spectrum data is retained in memory until the next identification or search. You can decide whether or not to save it from the Survey Mode screen.

3.2.4. View Found Nuclides List for Classify ID Display Mode

Because the Classify ID Display Mode lists categories instead of specific radioisotope names, the Detective-EX provides a screen that lists the **Found Nuclides** (and **Suspect Nuclides** in

LCX Mode). To view the found nuclides, simply tap on any of the ID messages on the ID Mode screen. The first tap will open the **Found Nuclides** report (see Fig. 28). Each ID will have a red, yellow, or green background corresponding to its threat level as described in Chapter 4. To access the Suspect Nuclides report in LCX Mode, tap an ID message on the Found screen. The report screens let you **Save** the current spectrum and identification results to disk and **Display** the current spectrum. Tap **Back** to return to the main Identification Mode screen.

3.2.5. Intense (View Highest-Intensity Spectrum Lines)

Tap **Intense** to view the list of most intense gamma-ray lines in the spectrum. The most intense lines list is a continuously updating list of the 10 best peaks currently detected (Fig. 29).

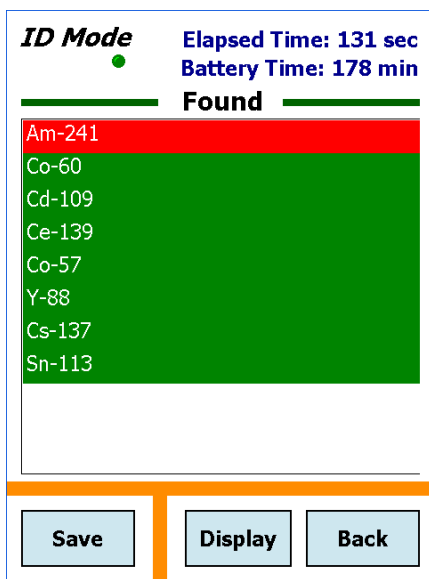

Figure 28. View Found Nuclides List.

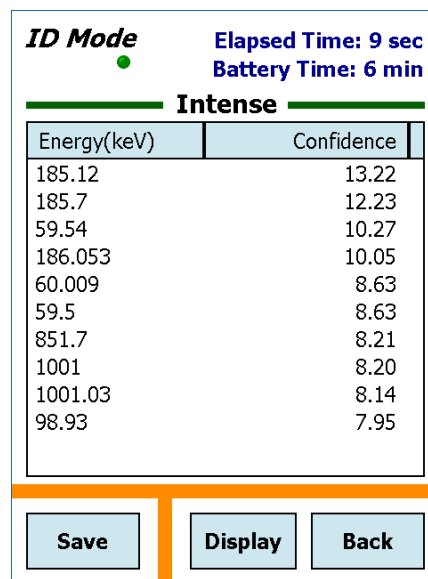

Figure 29. View Top Lines.

The energies are based on the internal nuclide library. The rank is based on the confidence value for the peak. When a detected energy matches an entry in the library, its tentative identity is posted on this screen, by peak energy, in column 1; and ID confidence factor (also called the *Q* value), in column 2. The higher the confidence value, the more likely that the peak is a real gamma ray peak and not background noise. It should be understood, however, that a peak could be seen in the top lines list but the corresponding nuclide not reported as found. This is because there are many other tests applied before an identity or tentative identity is chosen. In general, any Confidence value over 25 indicates a good peak.

To return to the Identification Mode tap **Back**.

Tap **Save** to save the current spectrum and identification results in the selected data storage location and file format(s). Tap **Display** to view the current spectrum (see Section 3.2.6).

3.2.6. Display Spectrum

The Display screen (Fig. 30) plots the gamma-ray energy spectrum currently in memory. This feature gives the expert spectroscopist more information about the nuclides present. The expert can then make more informed decisions about the material under investigation.

To enter Display Mode, tap the **Display** button. See the **Display Controls** discussion below.

Tap **Save** to save this spectrum and identification results to the selected data storage location and file formats. Tap **Back** to return to the previous dialog.

Because the spectrum display area is limited, a modified version of scientific notation is used when labeling the Y axes for numbers greater than or equal to 10,000: The number of trailing zeros in the number is replaced by “E” followed by the number of zeros. Some examples: 10,000 becomes **1E4**; 12,000 becomes **12E3**.

The spectrum display has a vertical marker line. Just below the spectrum is shown the position of the marker in the spectrum (in keV) and the counts in the marker channel. To move the marker line to a different location, tap the desired position. The marker will jump to that location and the values will update correspondingly. You can also press on the display area and drag the marker left or right to the new location.

3.2.6.1. Display Controls

The spectrum display control buttons are just below the display. You can use them to show the spectrum in different ways for better interpretation of the spectrum.

- **Full/Zoom** — In the expanded view, the **Full** button restores the display to 8000 channels. In the full view, the **Full** button changes to **Zoom** and zooms the display to the last horizontal expansion before **Full**. In this way, you can easily look at the peaks in the spectrum in detail (**Zoom in**) and move quickly from energy to energy in Full mode.

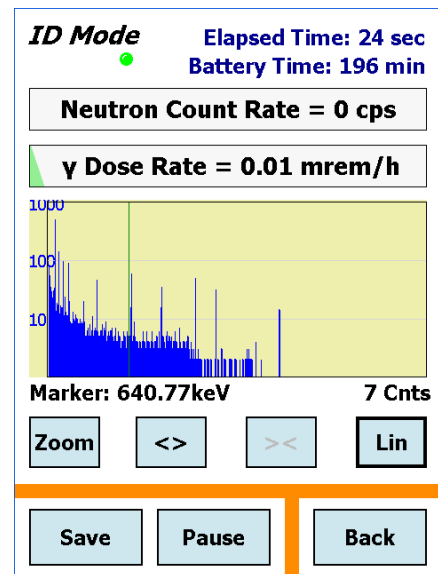

Figure 30. Spectrum Display Mode.

- **Zoom In** <> — The <> button expands the display by halving the number of channels, so the peaks appear wider. The center channel of the new display will be the marker position.
- **Zoom Out** >< — The >< button contracts the display by doubling the number of channels, so the peaks appear narrower. The center channel of the new display will be the marker position or channel 0 is the leftmost corner of the display or channel 8192 is the rightmost corner of the display.
- **Lin/Log** — The **Lin** button changes the vertical display to linear mode and automatic vertical limits. The **Lin** button changes to **Log** in the linear mode. Tap **Log** to change the vertical scale to log mode.
- **Pause/Continue** — If the Detective-EX is acquiring data, you can pause the data collection and resume it later. Tap **Pause** to stop collection. The button will change to **Continue** in the pause mode. Tap **Continue** to resume the data collection.

3.3. Search Mode

The Search Mode screen is a “strip-chart” emulation that displays total count rate (gamma and neutron) vs time (see Fig. 31). The gamma-ray data are presented in blue and the neutron data are shown in red.

Because the spectrum display area is limited, a modified version of scientific notation is used when labeling the Y axes for numbers greater than or equal to 10,000: The number of trailing zeros in the number is replaced by “E” followed by the number of zeros. Some examples: 10,000 becomes **1E4**; 12,000 becomes **12E3.0** cps and the neutron data are scaled from 0 to 500 cps.

The Y-axes can be autoscaled (**Scaled Y**) so the current maximum Y value for both counts is near the top of the graph, as shown in Fig. 31; or fixed (**Fixed Y**) such that the gamma-ray data are scaled from 0 to 1000.

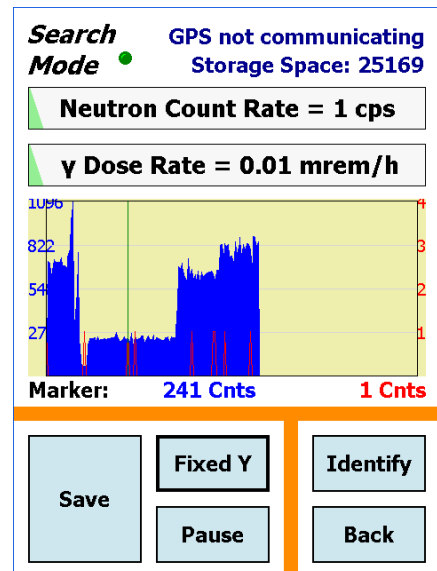

Figure 31. “Strip Chart” Emulation With Autoscaled Y-Axes.

- To start a search session, tap **Search** in the Survey Mode or any other dialog with the **Search** button. *If you wish to save the spectral data from the preceding identification or search session, you must do so before starting the new search* (tap **Display**, then **Save**).

The search will continue until you stop it, but only the most current count rate values (the newest 221) are displayed and can be saved.

- To save the displayed search results, tap **Save**. If the **Ask for Sample Description** option is enabled on the Spectra setup screen (see Fig. 74, page 66), a soft keyboard will open so you can enter a description for this data acquisition; tap **Set** to complete the save. If saving in ORTEC **.CHN** format, two count-rate “strip chart” files are saved for each search, one for the gamma count (labeled with a **G** suffix) and one for the neutron count (with an **N** suffix). For ANSI **.N42** files, one file with both gamma and neutron count rate (with a **B** suffix) is created. The filenames are automatically generated (Section 1.4.2) and saved according to the spectrum settings (Section 5.3.3).
- To pause a search acquisition, tap **Pause**. The **Pause** button will change to **Continue**, as shown in Fig. 32. Tap **Continue** to resume the search. The display will be continuous, that is, it will not show a gap that spans the paused time.
- To go directly to the Identification Mode, tap **Identify**. If you have not already saved the current Search data, they will be lost when you change modes.
- To end this search and return to the Survey Mode (Fig. 23), tap **Back**. The current search data will be retained until the next identification or search. (You can display the most recently acquired search or identification spectrum from the Survey Mode screen.)

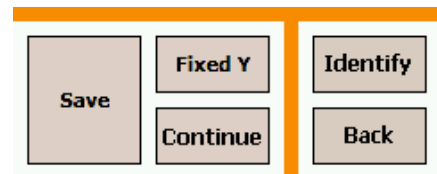

Figure 32. The Search Mode, Paused.

3.4. Monitor Mode

Use the Monitor Mode (Fig. 33) to identify radio-nuclides while moving relative to object(s) of interest. An example application is an *ad hoc* portal monitor where packages or people pass by the instrument. This mode is also useful as a search tool where the instrument is carried by the user in an effort to locate and identify a radioactive source.

The Detective collects one spectrum per second, and analyzes a rolling window of the eight most recent 1-second spectra for radioisotope IDs. This makes it particularly suited to situations where a completely different set of objects may be presented to the instrument in that time interval.

Each ID’s background is color-coded according to its threat status (see the ID table in Chapter 4): red for threat nuclides; green for innocent; and, in LCX Mode only, yellow for suspects.

Each ID persists until you tap to acknowledge it — this ensures that no ID goes unnoticed. Once acknowledged, the ID then persists until the source that triggered it is no longer being detected.

3.5. SNM Search Mode

The SNM Search Mode screen (Fig. 34) displays bar graphs showing how closely identifications of ²³⁹Pu, ²³⁵U, and neutron flux approach user-selected detection thresholds. The thresholds are set on the SNM Search Mode setup dialog under Advanced Settings (Section 5.2.6). Because ¹³³Ba can be used as a plutonium surrogate, advanced users can enable a ¹³³Ba search for training purposes and for developing a site’s concept of operations. If the ¹³³Ba search is disabled, its bar graph is not displayed on the SNM search screen.

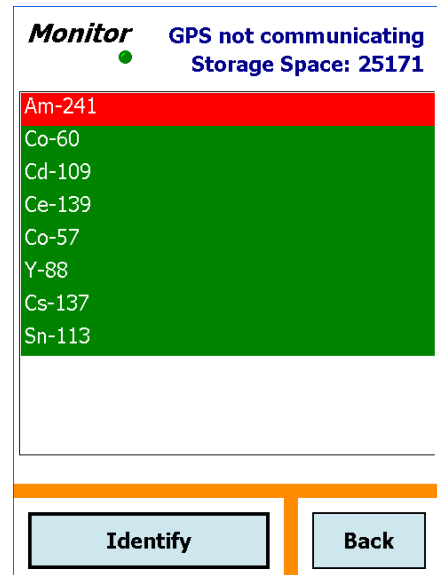

Figure 33. Monitor Mode.

SNM searches cannot be saved; to collect data that can be saved and reviewed later, tap **Identify**.

Figures 34 through 37 depict a search in which ¹³³Ba is detected. At the start of the search, the status message says **Continue to search** (Fig. 34). This message is displayed until the detection threshold for any one of the radionuclides or neutrons is crossed. As a ¹³³Ba source is approached, the confidence bar associated with it begins to lengthen and approach the threshold (Fig. 35).

As the Detective-EX comes close to the ¹³³Ba source, the identification for the radionuclide exceeds the threshold. The confidence bar enters the shaded part of its box, and the shading turns red to indicate the radionuclide has been found (Fig. 36). Figure 37 shows a high-probability hit. To verify the presence of SNM, tap **Identify** to switch to Identification Mode.

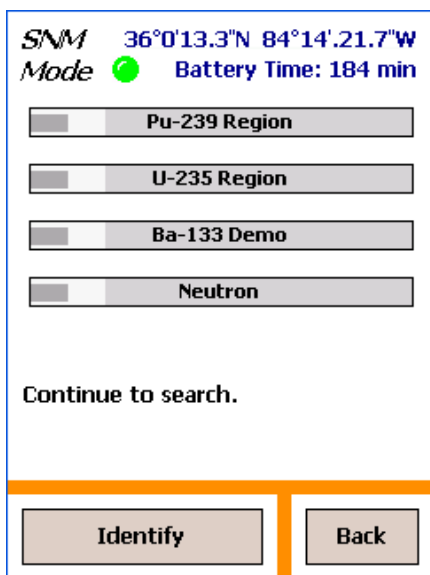

Figure 34. SNM Search Under Way.

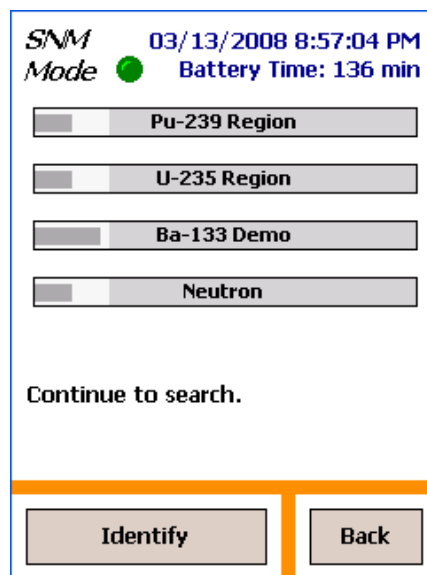

Figure 35. ¹³³Ba Threshold Almost Exceeded.

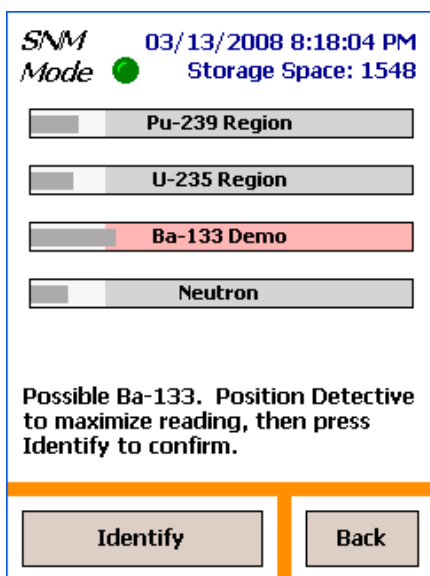

Figure 36. ¹³³Ba Tentatively Detected.

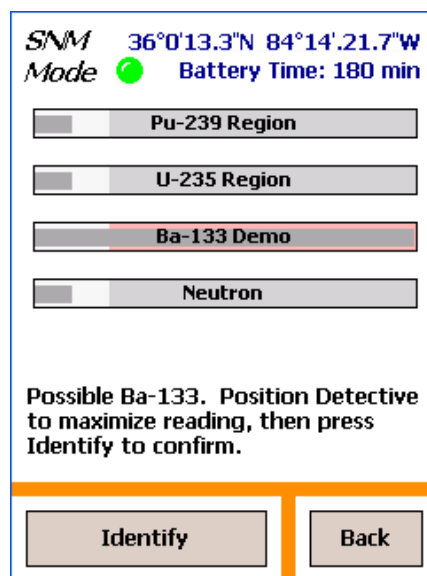

Figure 37. High Confidence That ¹³³Ba Has Been Detected. Use Identification Mode to Verify.

[Intentionally blank]

4. IDENTIFICATION MESSAGES AND RADIONUCLIDE LIBRARY

This chapter provides the list of identifications for the v8.6 nuclide library, and their categorization in the “Classify” and “ANSI” ID Display Modes (Section 5.2.3).

Identification	Category	
	Classify Mode	ANSI Mode
186 keV peak present	Suspect	Uranium
2614 keV peak present	Suspect	Uranium
375/414 peak present	Suspect	Plutonium
Ac-225	Innocent	Medical
Ac-227	Innocent	Industrial
Ag-110m	Innocent	Industrial
Am-241	Threat	Industrial
Am-241 (shielded)	Threat	Plutonium
Am-241 (unshielded)	Innocent	Industrial
Ar-41	Innocent	Industrial
As-72	Innocent	Industrial
As-74	Innocent	Medical
At-211	Innocent	Other
Au-198	Innocent	Industrial
Ba-133	Innocent	Industrial
Ba-140	Innocent	Industrial
Be-7	Innocent	Industrial
Beta emitter	Innocent	Bremsstrahlung
Bi-207	Innocent	Other
Bi-212 (Th-232/U-232 daughter)	Innocent	Industrial
Bi-214 (Ra-226 daughter)	Innocent	NORM
Br-76	Innocent	Other
Br-76 (heavily shielded)	Innocent	Other
Br-76 (shielded)	Innocent	Other
Br-77	Innocent	Industrial
Ca-47	Innocent	Industrial
Cd-109	Innocent	Other
Cd-115	Innocent	Industrial
Ce-139	Innocent	Medical
Ce-141	Innocent	Medical
Ce-144	Innocent	Industrial
Cm-242	Innocent	Industrial
Cm-243	Innocent	Industrial
Cm-244	Innocent	Industrial

Identification	Category	
	Classify Mode	ANSI Mode
Co-55	Innocent	Industrial
Co-56	Innocent	Other
Co-56 (shielded)	Innocent	Other
Co-57	Innocent	Industrial
Co-57 (shielded)	Innocent	Industrial
Co-58	Innocent	Medical
Co-60	Innocent	Industrial
Cr-51	Innocent	Other
Cs-131	Innocent	Medical
Cs-134	Innocent	Industrial
Cs-137	Innocent	Industrial
Cu-64	Innocent	Other
Cu-67/Ga-67	Innocent	Medical
Enriched Uranium	Threat	Uranium
Eu-152	Innocent	Other
Eu-154	Innocent	Other
Eu-155	Innocent	Other
Eu-156	Innocent	Other
Fe-59	Innocent	Other
Ga-64	Innocent	Other
Ga-64 (shielded)	Innocent	Other
Ga-67	Innocent	Medical
Ga-67 (shielded)	Innocent	Medical
Gd-153	Innocent	Other
Gd-159	Innocent	Other
Ge-68/Ga-68	Innocent	Medical
HEU	Threat	Uranium
Hf-181	Innocent	Industrial
Hg-203	Innocent	Industrial
Ho-166	Innocent	Other
Ho-166m	Innocent	Industrial
Ho-166m (shielded)	Innocent	Industrial
I-123	Innocent	Medical
I-123 (shielded)	Innocent	Medical
I-124	Innocent	Medical
I-125	Innocent	Medical
I-126	Innocent	Industrial
I-126 (shielded)	Innocent	Industrial
I-131	Innocent	Medical

Identification	Category	
	Classify Mode	ANSI Mode
I-131 (shielded)	Innocent	Medical
I-132	Innocent	Industrial
I-133	Innocent	Industrial
I-134	Innocent	Industrial
I-135	Innocent	Industrial
In-111	Innocent	Medical
Ir-192	Innocent	Industrial
Ir-192 (shielded)	Innocent	Industrial
Ir-194 (shielded)	Innocent	Other
K-40	Innocent	NORM
Kr-87	Innocent	Industrial
Kr-88	Innocent	Industrial
Kr-88 (shielded)	Innocent	Industrial
La-138	Innocent	NORM
La-140	Innocent	Other
Lu-172	Innocent	Medical
Lu-176	Innocent	NORM
Lu-177	Innocent	Medical
Lu-177m	Innocent	Medical
Mn-52	Innocent	Industrial
Mn-54	Innocent	Other
Mn-56	Innocent	Industrial
Mo-99	Innocent	Medical
Na-22	Innocent	Other
Na-24	Innocent	Medical
Nb-92m	Innocent	Industrial
Nb-94	Innocent	Industrial
Nb-95	Innocent	Industrial
Nb-96	Innocent	Industrial
Nb-96 (shielded)	Innocent	Industrial
Nd-147	Innocent	Industrial
Neutrons	Threat	Other
Neutrons CR	Threat	Neutron
Neutrons on Fe	Threat	Other
Neutrons on Hydrogen	Threat	Other
Np-237	Threat	Nuclear Neptunium
Os-194/Ir-194	Innocent	Other
Pa-231	Innocent	Industrial
Pb-203	Innocent	Industrial

Identification	Category	
	Classify Mode	ANSI Mode
Pd-103	Innocent	Medical
Po-210	Innocent	Other
Pr-144	Innocent	Industrial
Pu-238	Threat	Nuclear Plutonium
Pu-239	Threat	Nuclear Plutonium
Ra-223	Innocent	Industrial
Ra-226	Innocent	NORM
Rb-83	Innocent	Medical
Rb-86	Innocent	Medical
Rh-105	Innocent	Industrial
Ru-103	Innocent	Industrial
Ru-106/Rh-106	Innocent	Medical
Ru-97	Innocent	Industrial
Sb-124	Innocent	Industrial
Sb-124 (shielded)	Innocent	Industrial
Sb-125	Innocent	Industrial
Sb-127	Innocent	Industrial
Sc-46	Innocent	Medical
Se-75	Innocent	Medical
Sm-153	Innocent	Medical
Sm-153 (shielded)	Innocent	Medical
Sn-113	Innocent	Other
Sr-82/Rb-82	Innocent	Medical
Sr-85/Kr-85	Innocent	Industrial
Sr-89	Innocent	Medical
Ta-182	Innocent	Other
Tc-96	Innocent	Industrial
Tc-99m	Innocent	Medical
Te-132	Innocent	Industrial
Th-229	Innocent	NORM-Th
Th-230	Innocent	NORM-Th
Th-232	Innocent	NORM-Th
Tl-200	Innocent	Other
Tl-201	Innocent	Medical
Tl-202	Innocent	Other
Tl-204	Innocent	Medical
Tm-170	Innocent	Medical
Tm-171	Innocent	Industrial
U-232	Threat	Nuclear Uranium

Identification	Category	
	Classify Mode	ANSI Mode
U-233	Threat	Nuclear Uranium
U-235	Threat	Nuclear Uranium
U-238	Threat	Nuclear Uranium
Unknown Peak	Threat	Other
Unknown/Beta emitter	Threat	Other
V-48	Innocent	Medical
W-187	Innocent	Industrial
W-188/Re-188	Innocent	Industrial
Xe-127	Innocent	Industrial
Xe-131m	Innocent	Other
Xe-133	Innocent	Medical
Xe-133m	Innocent	Medical
Xe-135	Innocent	Other
Y-88	Innocent	Other
Y-91	Innocent	Industrial
Yb-169	Innocent	Medical
Zn-62	Innocent	Medical
Zn-65	Innocent	Medical
Zr-95	Innocent	Medical

4.1. Comments on Classify Mode Messages

The following explains the criteria for selected Classify ID Display Mode messages.

HEU (highly enriched uranium)

This message is displayed if the major lines of uranium are detected, and the ratios of the intensities of the lines indicates the ^{235}U content to be above about 70%.

Am241 (unshielded) in the “Industrial” category

This message is displayed if the 59 keV peak is located. It could mean that an ^{241}Am source such as a smoke detector is present. Move closer to the source and/or count longer. This will allow the higher-energy gamma rays to accumulate in the spectrum, in case plutonium is also present.

Unknown peak and Unknown/Beta emitter

This indicates the gamma count rate is higher than can be accounted for based on the peaks in the Detective-EX library. The implication is that either an unexpected nuclide or a beta

emitter is present (beta emitters typically producing counts over a broad range of energies). Move closer to the source and count longer to determine the nature of the suspect item.

4.1.1. Comments on “Found Nuclide” Screen Messages

RDD Detected

This message is posted when calculated activity is >100 mCi, whether the activity is from threat or innocent nuclides. The gamma count-rate and dose-rate meters on the Survey Mode and ID Mode screens display a flashing red background and extremely high count and dose rates.

5. ADVANCED SETUP

The three-page Advanced Setup menu covers tasks that are not typically required every work session and that require some knowledge of gamma-ray spectroscopy and/or radiation monitoring. The Detective saves all settings and uses them until the next time they are changed. Figure 38 shows the first page.

- Tapping the **Next**>> and **Previous**<< buttons moves you between the three menu screens.
- Tapping **Back** returns you to the Survey Mode screen.

NOTE You can set a password on the **Settings** screen (Section 5.2.4.1) to restrict access to the second and third pages of the Advanced Setup menu. The first Advanced Setup page can be accessed by all users, allowing them to view the hardware status, perform calibrations and background measurements, turn the cooler on/off, etc., as described in the following section.

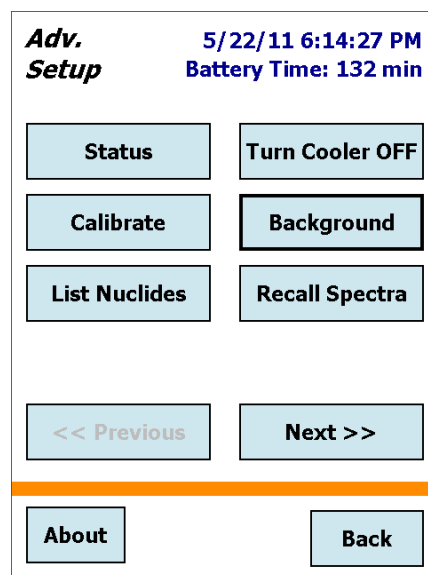

Figure 38. Advanced Setup, First Page.

5.1. Advanced Setup — Page 1

5.1.1. Status

The Status dialog (Fig. 39) allows you to monitor the hardware diagnostic and data acquisition parameters. The default view is a simplified “heads-up” OK/ERR readout. However, you can toggle between the simplified view and the actual readouts (Fig. 40) by tapping three times in the lower-left corner of the screen.

- The **Dead Time** is related to the current gamma count rate, and indicates the percentage of time the Detector is busy (i.e., not available to accept another pulse).¹¹

NOTE When the **Dead Time** exceeds 70% because you are near a very high-activity source (whether the source is an innocent or threat nuclide), *the detector is not able to process gamma radiation according to its performance requirements. A red indicator in the upper right corner of the screen tells you to MOVE BACK from the source until the dead time drops below 70% so that the*

¹¹This release of the Detective-EX software does not use the **Live Time** and **Real Time** fields.

instrument can perform as specified. See Fig. 15 (page 22) and its associated text.

Adv. Setup	GPS not communicating
	Storage Space: 25168
Live Time	0:15:06
Real Time	0:15:37
Dead Time	3.4%
Bias Voltage	OK
+12V	OK
-12V	OK
+3.3V	OK
Detector Temp	OK
Body Temp	OK
Cold Tip Temp	OK
Cooler Drive	OK
Ion Pump	OK
Gain Stabilizer	-3.80%
Back	

Figure 39. Status Dialog.

Adv. Setup	1/27/11 4:04:37 PM
	Battery Time: 196 min
Live Time	0:15:14
Real Time	0:15:46
Dead Time	6.9%
Bias Voltage	2610
+12V	12.00
-12V	-12.00
+3.3V	3.30
Detector Temp	116.00
Body Temp	35.00
Cold Tip Temp	114.00
Cooler Drive	5.75
Ion Pump	3299.0.0
Gain Stabilizer	-3.70%
Cooler Runtime	1023.99
Back	

Figure 40. Detailed Status Dialog.

- The remaining indicators are live (i.e., they continuously update to reflect current hardware conditions). For the first few seconds after you open this screen, the nine live indicators typically read **Waiting**, after which they acquire their actual current values or status messages (e.g., **OK**, **Error**, **Waiting**, **OFF**).

On startup and until the detector has cooled and the HV has automatically turned on, **Detector Temp**, **Cold Tip Temp**, and **Bias Voltage** read **Error**. Once cooldown is complete and the HV automatically turns on, these indicators change to **OK**. When the cooler is switched off, the **Cold Tip Temp** and **Cooler Drive** indicators read **OFF**.

The **OK** indicator means the parameter is within the allowed limits. The **Error** indicator means the parameter is outside the limits and must be corrected before the Detective-EX can be used. If the **Waiting** indicator persists beyond a few seconds *or if you receive an Error reading for any of these parameters after the nominal cooldown time has elapsed*, contact your ORTEC representative or our Global Service Center.

When all parameters are within allowed limits, the Survey Mode screen displays the **Ready** status message.

5.1.2. Turn Cooler Off/On

When the cooler is ON, the button reads **Turn Cooler OFF**. To turn the cooler off, tap this button, then confirm (see Fig. 41). The button title will change to **Turn Cooler ON**. Tap it to restart the cooler. When the instrument has cooled to operating temperature, the bias voltage automatically turns on.

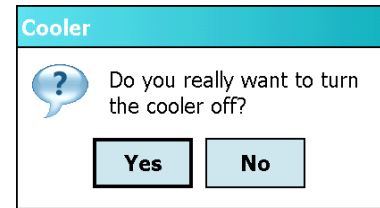

Figure 41. Turn Cooler Off?

NOTE The Detective-EX internal battery does not have enough power to start up the cooler or cool down the detector from room temperature, therefore, *external power is required*. In addition, an exhausted internal battery should be charged for 2 hours before the Detective-EX is cooled using external power. If you are using a standard 12 V auto-mobile battery as the external power source, the detector cooling can significantly discharge the battery. Cooler startup without external power cause operational anomalies; these are discussed in troubleshooting Sections 7.5 and 7.6.

You can turn the cooler off for 10–20 minutes without significantly warming the detector. As soon as the cooler is restarted, the Detective-EX typically shows a **Ready** status within a few seconds.

The cooler can be restarted at any time, without harming the detector crystal, regardless of whether the detector is warm, partially cooled, or cooled to the operating temperature range.

5.1.3. Calibrate (Manual)

This command starts the manual calibration routine, which checks and adjusts the Detective-EX electronics so that it correctly identifies the nuclides in the area. The calibration source to be used must be pre-set within the **Cal. Settings** function, as discussed in Section 5.2.1.

5.1.3.1. Start the Calibration

Position the indicated calibration source in front of the detector window, then tap the **Start Calibration Now** button shown in Fig. 42. The button name will change to **Abort Calibration** and the time remaining to complete calibration will be displayed as in Fig. 43. The time to completion is based on the peak count rate. Calibration will not succeed until the calibration peak passes the quality test.

You can abort the calibration process at any time; no changes will be made to the calibration coefficients (i.e., the existing calibration will still be in effect).

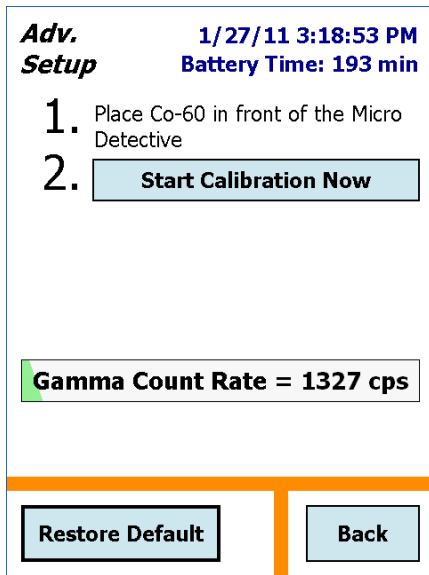

Figure 42. Start Manual Calibration.

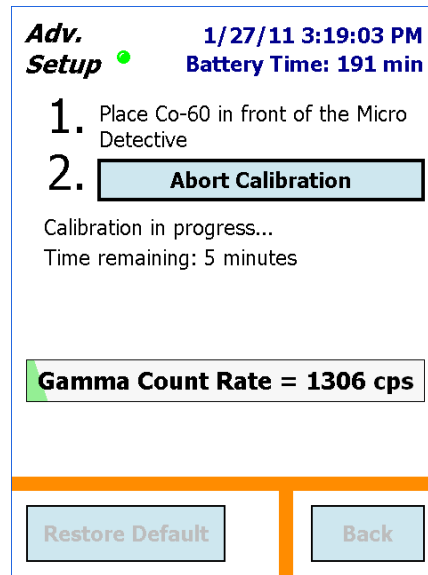

Figure 43. Wait for Completion.

At the end of the calibration period, the **Use Improved Calibration** button will be displayed (Fig. 44), along with the actual energy of the calibration source peak. For the factory-defined sources, the **Centroid** values should ideally be:

- ¹³⁷Cs — 661.62 keV
- ⁴⁰K — 1460.75 keV

In addition, the screen will display the full width at half-maximum (**FWHM**), an indicator of peak shape; and the calibration adjustment (**Cal. Adjust**). The calibration adjustment is the difference between the spectrum position of the calibration source's peak in the new calibration and the position of the same peak in the current calibration, expressed in energy, as a percentage of the actual peak energy.

5.1.3.2. Apply the Improved Calibration

When the calibration measurement is complete and the **Use Improved Calibration** button is displayed, choose whether or not to use this new calibration. Usually, the proposed change in calibration is quite small, and sometimes it is even zero. If it is larger than 0.3%, the cause should be investigated. To use the new calibration, tap **Use Improved Calibration**.¹²

¹²If the calibration fails, an error message will be displayed. For more detailed calibration troubleshooting, see Section 7.8.

5.1.3.3. Perform a Background Measurement

If you accept the improved calibration, the manual calibration routine deletes the existing background file. Therefore, the final step of the calibration process is to re-measure the background, as indicated in Fig. 45. Remove the calibration source, tap the **Run a Background** button, then refer to the instructions in Section 5.1.4.

NOTE When the previous background is no longer valid, the **Background Invalid** message is displayed on the Survey Mode screen. The Identify and Monitor buttons become inactive and the system will not post radionuclide IDs. However, the gamma and neutron count rate meters on the Survey, Search, and SNM Mode screens continue to function normally.

Tap **Back** to return to the Advanced Setup dialog.

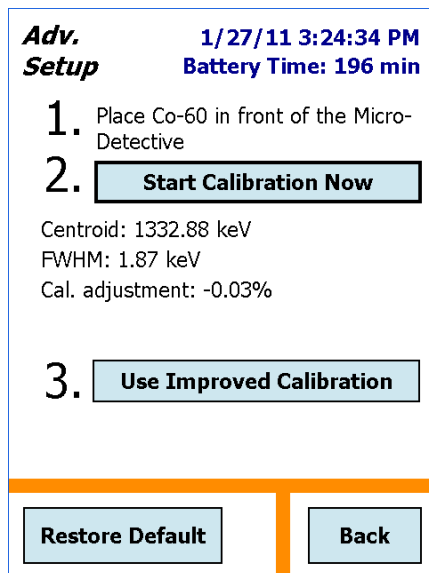

Figure 44. Apply The Calibration.

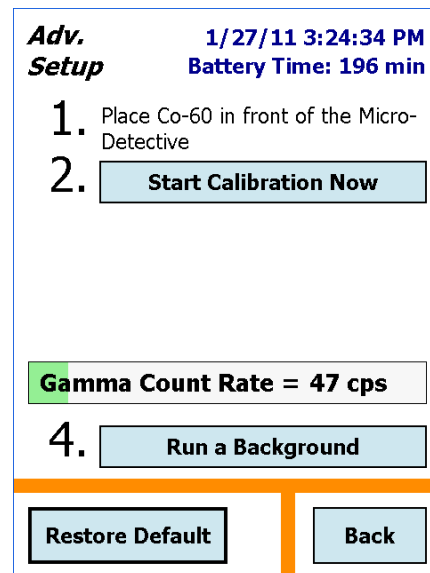

Figure 45. Run A New Background.

5.1.3.4. Restore Default

If you have changed the calibration now or at any time in the past, you can restore the factory calibration settings by tapping on the **Restore Default** button. The factory values are always available. Note that this feature is typically used for troubleshooting purposes. The current background file is destroyed, so you must run a new background before the Identify and Monitor Modes will function..

5.1.3.5. Back

If you do not want to apply the new calibration, tap **Back** to return to the Advanced Setup dialog. (However, if you have run this background as the final step of calibration, remember that you must run a new background before the Identify and Monitor Modes will function.)

5.1.4. Background

This command begins the background radiation measurement pre-configured with the **Bkg Settings** command discussed in Section 5.2.2.

To measure the background:

- Remove all sources from the area.
- Tapping the **Run a Background** button, at the end of the manual calibration routine, opens the screen shown in Fig. 46 and automatically starts the background acquisition.
- Acquisition continues until you tap either **Save** or **Cancel**, which will return you to the **Advanced** menu. *If the measurement is canceled before the minimum time has elapsed, the software does not accept (i.e., save and use) the new background spectrum.* Instead, it reverts to the existing back-ground file.¹³

5.1.5. List Nuclides (View Analysis Library)

This screen (Fig. 47) displays the current library of radionuclide IDs and library version. The complete list of IDs is in Chapter 4. If you wish, you can create a text file listing of the library entries by tapping **Save to File**. This creates the file **Nuclides.txt** in the Detective-EX's **My Documents** folder.

5.1.6. Recall Spectra

Recall Spectra lets you view stored **.SPC** spectrum files and their associated reports. It opens the Choose File dialog (Fig. 48), which displays the **Data Location** listbox and the list of spectra in the currently selected location. Select the desired data location, then use the scrollbar to browse up and down through the list of spectra. Tap **Back** when finished viewing spectra.

¹³As noted elsewhere, if you are running this background as the last step of the manual calibration routine, the Identify and Monitor Modes will be disabled until the background measurement is completed and accepted.

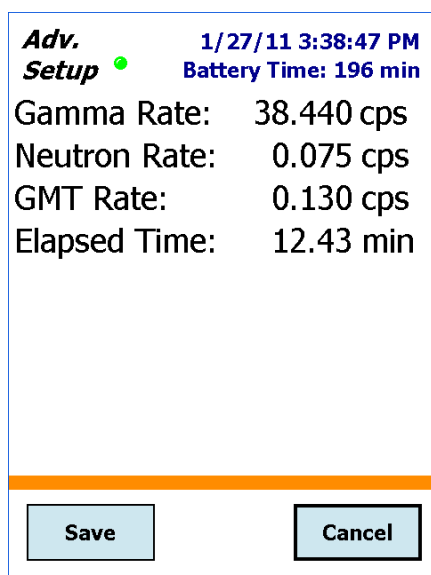

Figure 46. Collect Background for At Least the Specified Minimum Time.

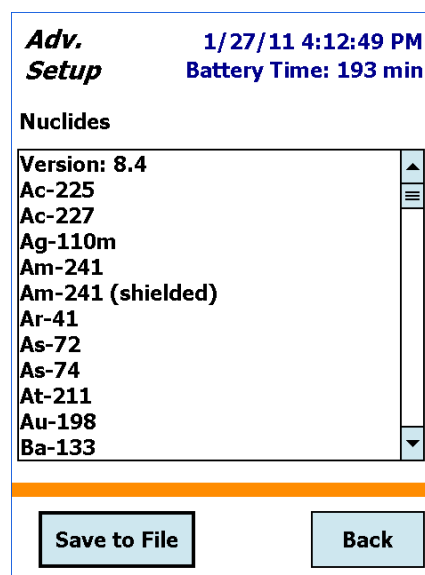

Figure 47. View the Radionuclide Library.

5.1.6.1. Viewing Stored Spectra

To display a particular spectrum file, tap the filename, then tap **Choose**. The histogram will be displayed along with the filename, as shown in Fig. 49. The spectrum display controls are discussed on page 35. To view the associated reports, see the next section.

5.1.6.2. Viewing Stored Spectrum Reports

Identification Mode spectrum files include both the spectrum and information on the radionuclides found during the identification session. When you display a stored spectrum, you can view this information by tapping the **ID** button below the spectrum display. This will open the **ID Report** screen (Fig. 50). Tap the listbox at the top of the screen to access the list of **Found Nuclides** (Fig. 51), **Suspect Nuclides** (for LCX Mode spectra only; Fig. 52), **Top Lines** (Fig. 53), and **GPS** (Fig. 54); some of the reports may contain no entries. Tap **Back** to return to Advanced Setup.

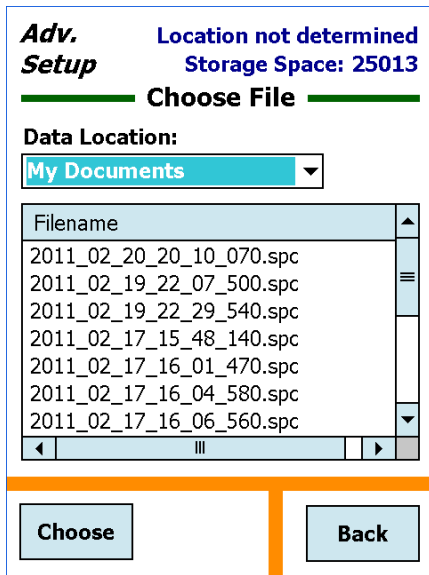

Figure 48. Spectrum Directory.

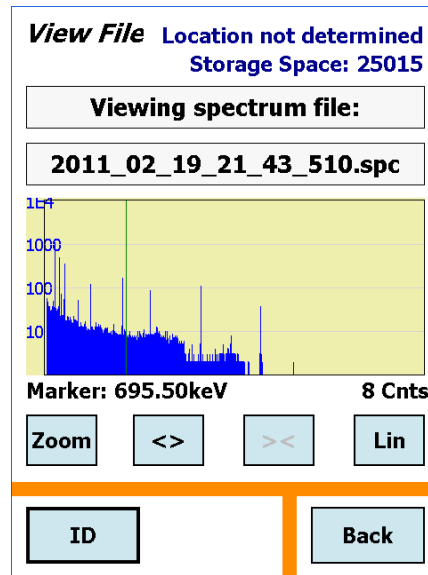

Figure 49. View Spectrum; Tap ID to View Reports.

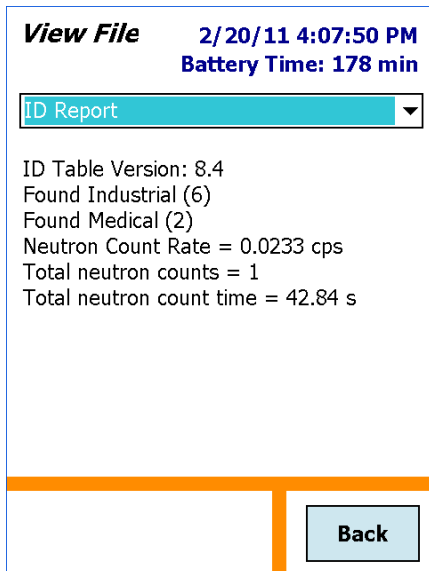

Figure 50. ID Report.

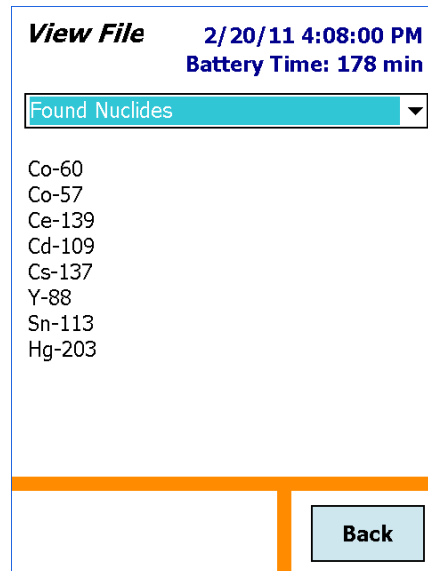

Figure 51. Found Nuclides Report.

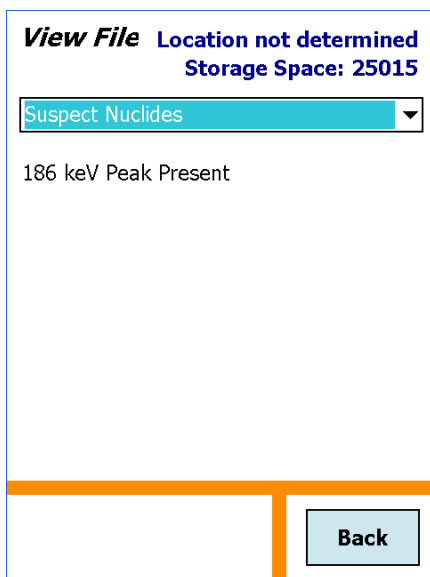

Figure 52. Suspect Nuclide Report (for LCX Mode spectra only).

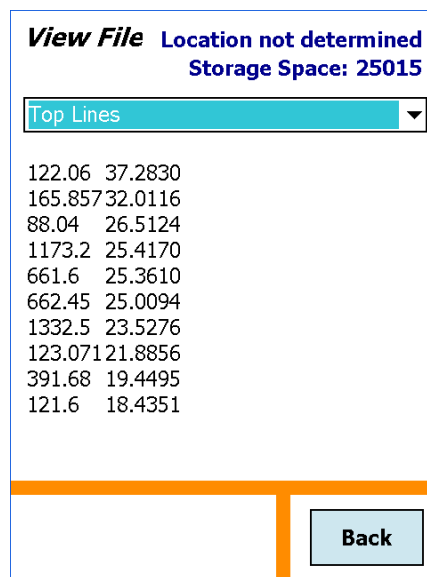

Figure 53. Top Spectral Lines.

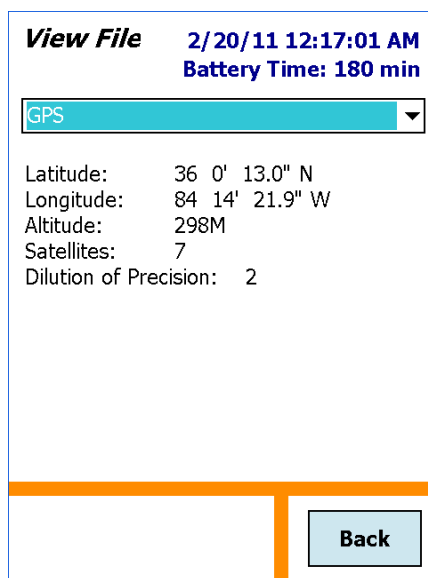

Figure 54. GPS Report.

5.1.7. About

This dialog (Fig. 55) shows the instrument type, presence or absence of neutron detector, firmware and application software version numbers, instrument serial number, and nuclide library version. Tap **Back** to return to the Advanced Setup menu.



Figure 55. The About Dialog.

5.2. Advanced Setup — Page 2

If a password has been set, the screen shown in Fig. 56 will be displayed. Tap in the password text box to open the soft keyboard. Enter the password and tap **OK**. If you entered the correct password (which is case-sensitive and treats spaces as characters), the second Advanced Setup page will be displayed (Fig. 57). For more information on the Password screen, see Section 5.2.4.1.

If the password was incorrect, the **Password invalid** message will be displayed. You may try to enter the password again or tap **Back** to return to the previous menu page. If no password was set, the Detective-EX will go directly to the second Advanced Setup menu screen.

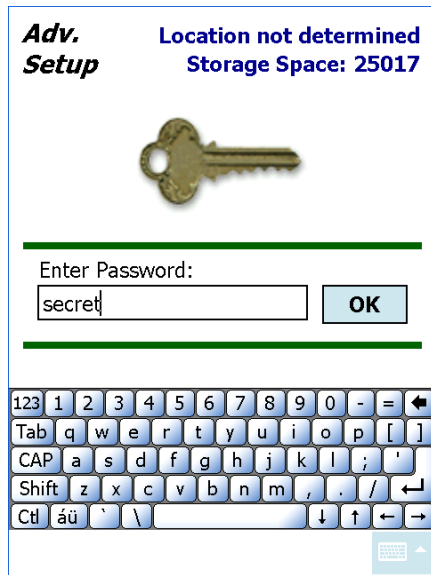

Figure 56. Enter the Password.

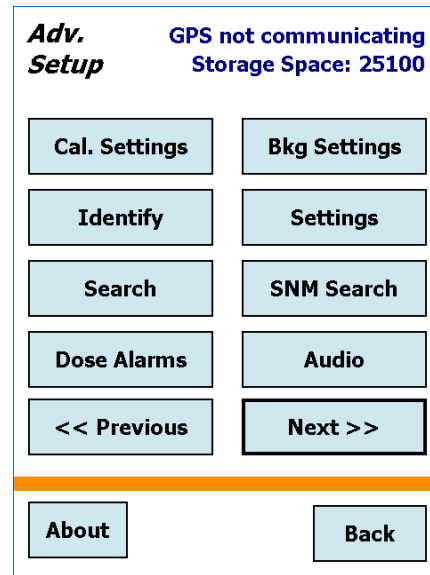

Figure 57. Advanced Setup, Second Page.

5.2.1. Calibration Settings and Auto-Calibration

Cal. Settings (Fig. 58) allows you to turn the auto-calibration check on and off, decide how often to auto-calibrate, and either choose a factory-defined calibration source (^{137}Cs or ^{40}K) or define up to two of your own calibration sources with the **Setup...** feature. The source selected here also determines the source used for the manual **Calibrate** feature discussed in Section 5.1.3.

The calibration routine checks and adjusts the Detective-EX's electronics so that it correctly identifies the nuclides in the area. This function searches for the calibration source peak in a window 30 keV wide, centered on the peak channel for the selected source. Once the peak is located and its net area reaches 4000 counts, the detector amplifier's fine gain setting is adjusted for optimum performance. Unlike manual calibration, auto-calibration does not delete the existing **background.chn** file so there is no need to take a new background measurement afterwards.

- To choose a calibration source, tap the source list at top left and make your selection.
- To define a calibration source (up to two),¹⁴ tap the **Setup...** button to open the screen shown in Fig. 59. Tap in the **Source Name** field and use the soft keyboard to enter the name, tap in the **Energy Peak** field and enter the peak energy in keV, then tap **Back**

¹⁴If you wish, you may delete the factory-defined sources; they can be restored to the source list at any time.

to return to the calibration settings screen. The new entry will be available on the source list.

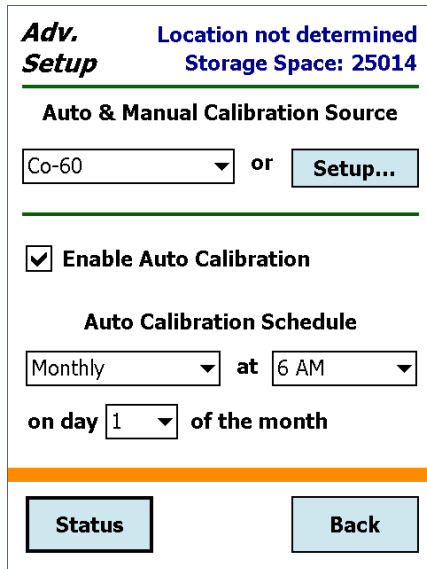

Figure 58. Set Up the Auto-Calibration Feature.

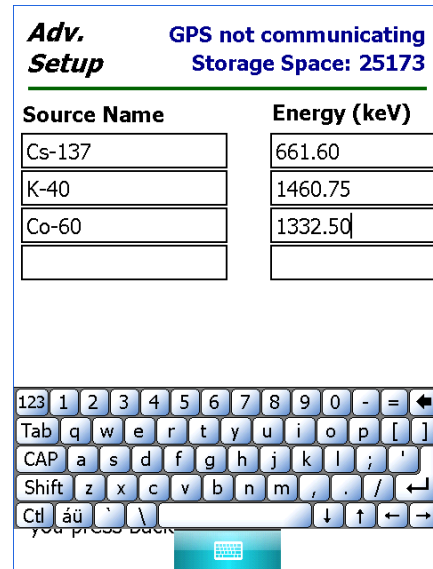

Figure 59. Enter the Peak Energy for a Calibration Source.

- To use the auto-calibration feature, mark the **Enable** box by tapping it. To disable auto-calibration, simply unmark the box.

Set the auto-calibration interval by tapping the **Schedule** lists and selecting the desired time of day as well as one of the following intervals:

- Daily.
- Weekly; choose the **Day** of the week.
- Monthly; tap in the **Day of the month** field and use the soft keyboard to enter the day.

5.2.1.1. Setup Requirements for Successful Auto-Calibration

For **Auto Calibration** to run successfully:

- The **Auto Calibration** checkbox must be marked (enabled).
- The Detective must be in Survey Mode (not in another monitoring mode).
- The detector status must be **Ready**.
- The unit must be properly connected to external power.
- The appropriate source must be in position.

5.2.1.2. Auto-Calibration

- During auto-calibration, the screen displays the time remaining to completion of the calibration, as shown in Fig. 60. This number is the real time for the calibration spectrum acquisition and is based on the peak count rate. Auto-calibration will not succeed until the calibration peak passes the quality test.
- If the unit does not detect the correct calibration source, it waits for approximately for 2 minutes, then posts an error message. Tap **Back** to return to the Survey Mode. You can either use the existing calibration or perform a manual calibration. The unit will auto-calibrate at the next scheduled interval.
- To interrupt auto-calibration, tap the **Abort** button, then **Back** to return to Survey Mode. When you return the Detective-EX to the auto-calibration function, calibration will immediately restart from the beginning. The unit will continue trying to calibrate until the calibration peak passes the quality test.
- If you disconnect the instrument from the external power source during auto-calibration, the routine will attempt to run to completion. Tap on the **Abort** button to interrupt auto-calibration, then **Back** to return to Survey Mode. When the unit is reconnected to external power, auto-calibration will start at the next scheduled interval.

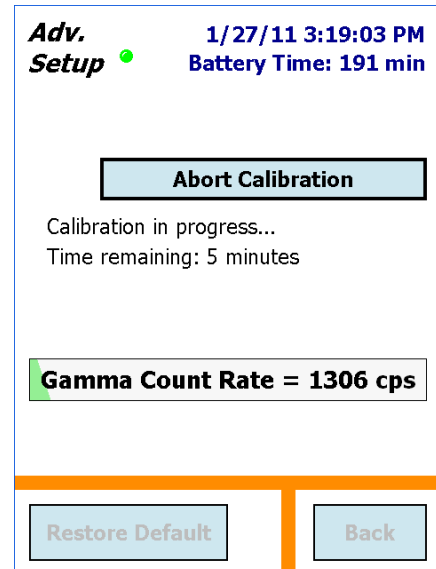

Figure 60. Auto-Calibration in Progress.

5.2.2. Background Settings

Use this screen to pre-configure the minimum accept-able background radiation measurement time for the **Background** command (Section 5.1.4). The instrument requires periodic measurement of a site's background radiation to reduce false alarms on ⁴⁰K and other naturally occurring radioisotopes from building materials such as concrete. The background file is saved on the computer in `\Program Files\DetectiveEX`. It is stored as an ORTEC `.CHN` spectrum file named `background.chn`, and is overwritten each time the background is updated. Ideally, a new background measurement should be made whenever the Detective-EX is moved to a new site. In addition, a new background is required as the final step of calibration.

The minimum acceptable data collection time for the background measurement is set on the **Bkg Settings** screen, shown in Fig. 61.

NOTE For optimum counting statistics, we strongly recommend a minimum 30-minute background acquisition (the longer, the better). However, the background settings screen also allows you to set a minimum interval of 1, 5, or 15 minutes.

5.2.3. Identify (Identification Mode) Settings

This dialog (Fig. 62) lets you set a counting preset; choose to display radionuclides by category (e.g., Industrial, NORM, Medical, etc.) or by radioisotope name; enable/disable the expert LCX identification mode, and turn color-coded IDs on/off.

5.2.3.1. Real Time Preset

To set a preset acquisition time for Identification Mode, tap in the field to open the soft key-board, enter a count time from 1 second to 9999999 seconds, and tap **Set**.

In preset mode, the **Pause/Continue** button allows you to extend the count. For more information and an example, see Section 3.2.2.

5.2.3.2. ID Display Mode

Choose whether to display identifications by radioisotope name (**ANSI**); or by category (**Classify**), for instance **Industrial, Medical, NORM-Th**. Figures 25 and 26 on page 32 compare how the same detected radionuclides are displayed in ANSI mode and Classify mode.

See also Chapter 4, which lists all Identification Mode messages, their threat/suspect/innocent status, and Classify mode category.

5.2.3.3. LCX (Low-Confidence Expert) ID Mode

The LCX identification mode displays suspected threat alarms and identifications at an approximately 30% lower confidence level than the normal mode. This results in more hits on suspected threat nuclides. Although detection

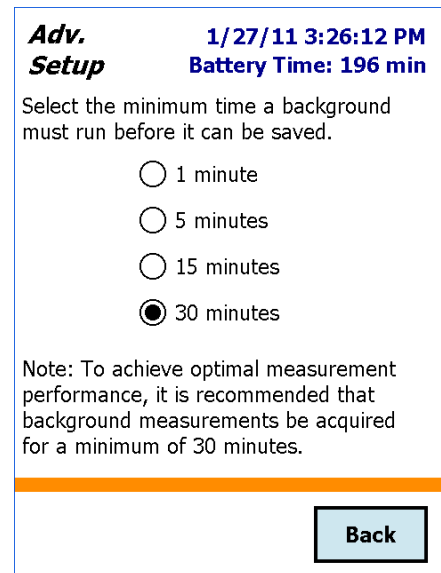

Figure 61. Set the Minimum Background Acquisition Time.

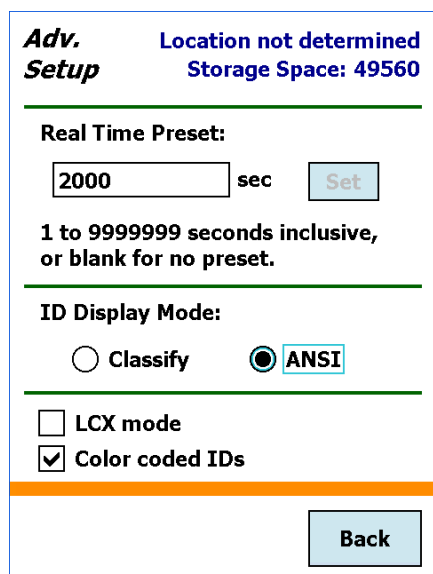

Figure 62. Identification Mode Setup.

is arguably improved in LCX mode, the false alarm rate will increase to a level unusable for many applications. *Be aware that the instrument will issue approximately two false suspect threat alarms every hour while in LCX mode. **Therefore, we recommend LCX mode only for experienced spectroscopists.***

To enable LCX Mode, mark the checkbox and click on **Back**. A blue simulated LED (●) will be displayed in the upper left of all screens, beside the screen title (Figs. 63 and 64). This shows you, at a glance, which radiation monitoring mode is currently selected.



Figure 63.



Figure 64.

Figures 65 and 66 compare how suspect identifications in LCX mode are displayed in the “Classify” and “ANSI” ID Display Modes (both screens reflect the same set of found and suspect substances). Note that in LCX mode, the **Color coded IDs** option is always on.

Found Plutonium (1)
Found Industrial (2)
Suspected Uranium (1)
Suspected Nuclear Uranium (2)

Figure 65. Suspect IDs in “Classify” Display Mode.

Am-241 (shielded)
186 keV Peak Present
U-235
U-238
Co-60
Cd-109

Figure 66. Suspect IDs in “ANSI” Display Mode.

5.2.3.4. Color Coded IDs

When this option is checkmarked (on), ANSI Mode nuclide IDs are displayed on a color-coded background indicating their threat/suspect/innocent status (refer to Figs. 25, 33, and 66). As noted in the preceding section, this option is always on in LCX mode.

5.2.4. Settings

5.2.4.1. Password

The **Settings** screen allows you to set a password to prevent unintended changes to the Advanced Setup parameters. The password is *case sensitive*, alpha-numerical, can include spaces, and can be of any length. There is no factory default.

To set the password, tap in the **Password** field to open the soft keyboard, as shown in Fig. 67. Enter the password and tap **Set**. The soft keyboard will close. To put the password into effect, tap **Back** to return to the Survey Mode screen.

To remove the password, tap the end of the password, delete all the characters by tapping the backspace soft key (**⬅**), then tap **Set**. *Tapping the spacebar to overwrite the characters does not work* (i.e., there is no overwrite capability, the “space” is treated as any other character).

NOTE *There is no master password so be sure to record your password, including uppercase and lowercase letters. If you lose this password, contact your ORTEC representative or our Global Service Center for assistance.*

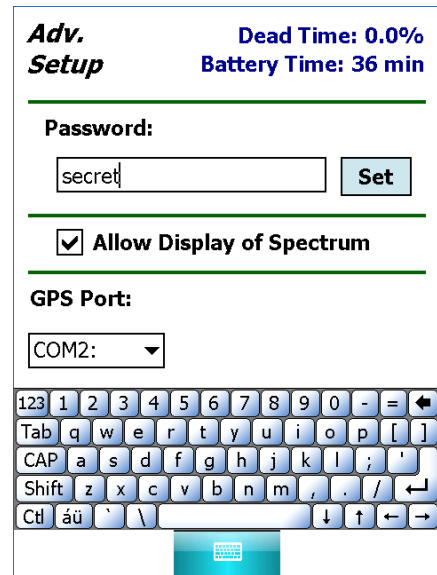

Figure 67. Enter a Password and Tap the Set Button.

5.2.4.2. Allow Display of Spectrum

This allows an administrator to hide the Display Mode by locking the spectrum display. When the display is locked, none of the **Display** buttons will be shown on the dialogs. To lock the display, tap the checkbox to mark it. To restore access to the spectrum display, tap the checkbox again to unmark it.

- To prevent spectra from being viewed on the Detective screen, unmark the **Allow Display of Spectrum** checkbox, then set a password in the Advanced Setup dialog (Section 5.2.4.1).
- If the spectra must not be viewed at any time by anyone, we additionally recommend that the field operator not save them.

NOTE If spectra are saved (whether or not the Display Mode is locked), a properly configured computer and MAESTRO can still be used to view the saved spectra. In such cases, the Detective-EX (and any memory cards containing spectra) must be secured from unauthorized access according to your site operating procedures.

5.2.4.3. GPS Port

This is factory-set and will normally not be changed.

5.2.5. Search Mode Settings

This dialog (Fig. 68) allows you to set the data **Collection Time** for Search Mode. Search Mode tracks the total counts vs a specified period of time and presents the results in a “strip chart” emulation. The total counts in each time period are represented on the vertical scale, and the time period always occupies one pixel width on the display (that is, changing the dwell time does not change the width of the lines on the strip chart). Tap to select a dwell setting. As soon as you choose a new setting, it will go into effect.

5.2.6. SNM Mode Settings

Use this dialog (Fig. 69) to set the search acquisition **Dwell Time** for the SNM Search Mode (Section 3.5); and the detection threshold for **Pu-239**, **U-235**, and **Neutron** radiation. Advanced users can also choose to enable and configure a detection threshold for the plutonium surrogate **Ba-133** for training and site setup purposes (see the discussion in Section 3.5). If the **Ba-133** search is enabled, four bar graphs will appear on the SNM Search Mode screen instead of just three (see Fig. 34 on page 39). The **Dwell Time** setting is the same for all SNM radioisotopes.

To set the **Q Alarm Threshold** for each gamma emitter, tap the radioisotope name, tap in the threshold field to open the soft keyboard, enter the desired value, and tap **Set**. Figure 69 shows the setup dialog for **Pu-239**.

To set up the **Neutron** count rate (for units so equipped), in counts per second, tap the **Neutron** tab, tap in the threshold field to open the soft keyboard, enter the desired value, and tap **Set**.

To enable the **Ba-133** search (Fig. 70), mark the **Include in Search** checkbox and enter the desired alarm threshold value, then tap **Set**. When this feature is disabled, the **Ba-133** bar graph is not displayed on the SNM Search Mode screen.

Tap **Back** to return to the Survey Mode screen.

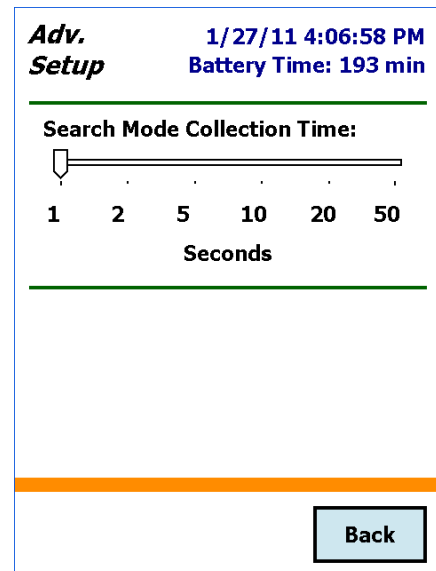

Figure 68. Search Time per Horizontal Unit Selection.

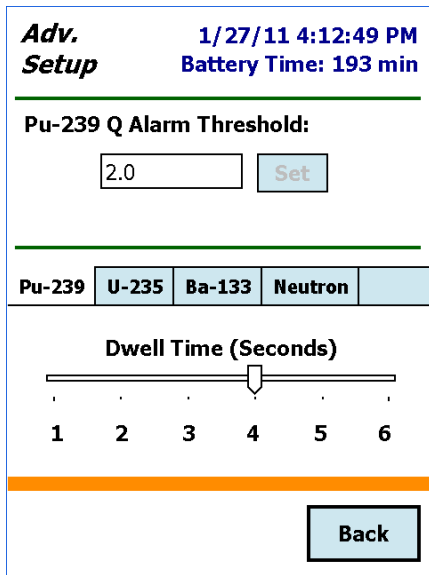

Figure 69. Configure the SNM Search.

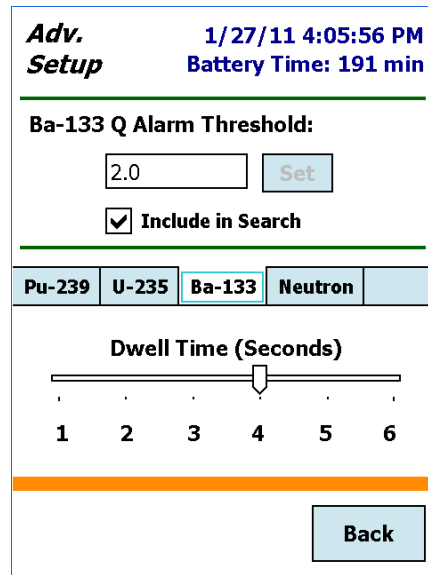

Figure 70. Enable the Ba-133 Search and Alarm Threshold.

5.2.7. Dose-Rate Units and Alarms

In all modes, the Detective-EX alarms audibly and visually at a gamma dose rate of 10,000 $\mu\text{Sv/hr}$ (1 rem/hr) and/or the neutron count rate >500 cps. Above these limits, the ID Mode’s Found Nuclide screen reports the message **RDD Detected**. The Dose Alarms dialog (Fig. 72) lets you optionally set lower thresholds for one or both types of radiation.

To set either **Threshold**, tap in the field to display the soft keyboard. Enter the desired value and tap **Set**.

You can choose display the gamma dose rate in microSieverts per hour ($\mu\text{Sv/hr}$) or millirem per hour (**mrem/hr**). The **Dose Units** status message updates immediately to reflect the new dose-rate unit. To change units, tap either the $\mu\text{Sv/h}$ or **mrem/h** radio button to mark it.

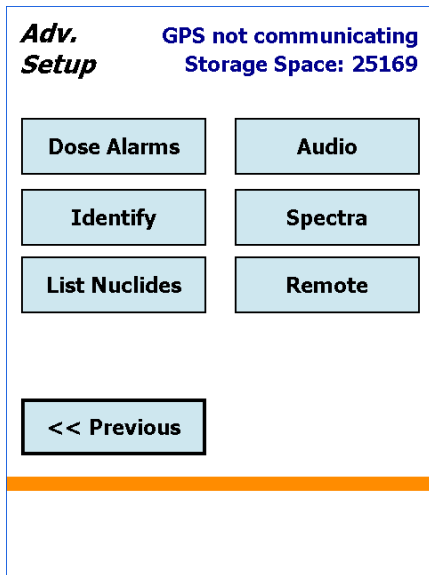

Figure 71. Advanced Setup, Second Page.

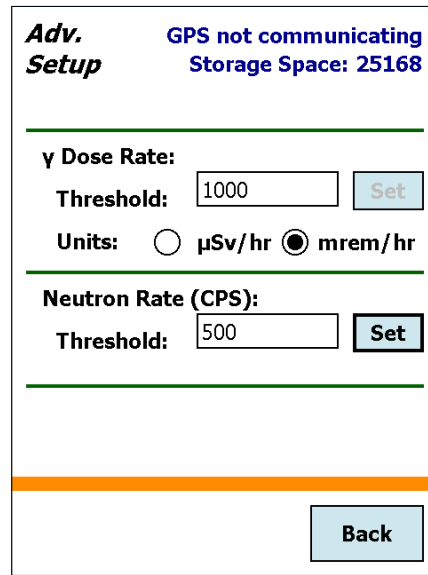

Figure 72. Set the Dose Rate Units and Alarm Thresholds.

5.2.8. Audio Settings

The Detective-EX has an audible clicker signal that registers the current the gamma count rate, and can be heard through headphones, the speaker in the Detective-EX case, or both. The neutron sensitivity is lower than the gamma sensitivity because the neutron count rate is lower.

To adjust the clicker volume, tap **Audio** (Fig. 73), then set the **Headphone Volume** or the **Speaker Volume**.

The two **Sensitivity** sliders let you choose the number of counts per click; the default is 1000 counts per click. To change clicker sensitivity, tap **Audio**, then set the gamma and neutron sensitivity to the desired level.

When finished, tap **Back**.

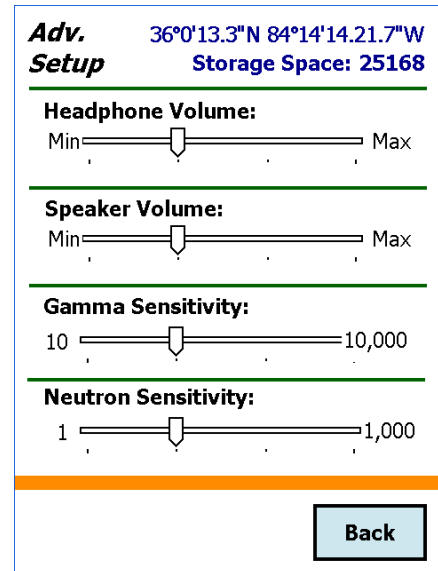

Figure 73. Change the Clicker Volume Settings.

5.3. Advanced Setup — Page 3

5.3.1. Remote

This screen is used by other ORTEC applications, such as the Detective-Mobile® system.

5.3.2. Exit

The **Exit** button is used to close the **DetectiveEX** software application and go to the computer operating system. This is not normally used, but could be needed from time to time. A confirmation dialog is displayed before the program exits. To return to the **DetectiveEX** program without exiting, tap **Cancel**. To restart the Detective application, tap **Start**, then locate and tap on the **DetectiveEX** program shortcut. (The application executable file is located in the **My Device\Program Files\DetectiveEX** folder.)

5.3.3. Spectra

The **Spectra** command opens the screen shown in Fig. 74, which lets you choose sample description options, the file storage location, and the file save formats. In addition, you can delete spectrum files.

The top right of the screen shows the number of spectra that can be stored (i.e., the remaining storage capacity) in the current storage location (refer to Fig. 14). Filenaming conventions are given in Section 1.4.2.

To view stored **.SPC** spectra and their associated reports, use the **Recall Spectra** command discussed in Section 5.1.6.

Stored spectra can be downloaded to a computer according to the instructions in Chapter 6.

5.3.3.1. Ask for Sample Description

Each spectrum has an identifier stored with it. You can set a description for each spectrum or they can all have the same description. If you want to enter a new description for each spectrum, tap the checkbox. If there is a checkmark in the box, each time you save a spectrum, you can enter the description in the dialog.

Adv. Setup 06/03/2010 3:34:32 PM
Storage Space: 1951

Ask for Sample Description

Default Description:
Site 21 Set

Data Location:
My Documents ▼

File Save Format:
Both ORTEC and ANSI ▼

Delete Back

Figure 74. Spectrum Description and Location Settings.

5.3.3.2. Default Description

The default description will be stored with every spectrum unless you change it. You can change it here, or you can change it when the spectrum is stored if you have marked the **Ask for Sample Description** checkbox. Tap in the dialog to display the soft keyboard and tap **Set** to save your entry.

When the **Ask** dialog is shown, the default description is in the dialog. You can add to it or change it completely. This is a good way to enter the main portion of the description ahead of time, then add a unique identifier, such as a sequence number, to each spectrum as it is acquired.

5.3.3.3. Data Location

This field (Fig. 75) allows you to choose the storage device or location for the spectrum storage. The location you choose becomes the default location on the spectrum display dialog. Tap the down arrow to open a list of valid locations, which for the Detective-EX are the computer's **My Documents** folder and the SD card, which will be indicated as **Storage Card/Data**. If the SD card is not present in its slot, it will not be on the list. Tap the location you want. Keep in mind that if the storage card fills up, the Detective will automatically begin saving spectra in its computer's **My Documents** folder.

5.3.3.4. File Save Format

The **DetectiveEX** application generates two basic types of files:

- Identification Mode gamma-ray spectra.
- Search Mode “strip chart” histograms of gamma (and optional neutron) count rate vs. time.

The **File Save Format** feature (Fig. 76) lets you choose to generate these files as ORTEC file formats, ANSI N42.42 format files (compatible with ANSI N42.42-2006), or both.

For more detailed information on file formats, see Section 1.4.2.

5.3.3.5. Delete Stored Spectra

To delete a stored spectrum file, tap **Delete**. This opens the Choose File dialog (Fig. 77), displaying the **Data Location** listbox and the list of spectra in the current location. Select the desired data location, then scroll up and down through the list of spectra. Files in **.SPC** format are listed first, in descending alphabetical order, followed by **.N42** files in descending alphabetical order, as shown in the figure. To delete a spectrum, tap the name and then tap **Choose**. You will be asked to either confirm or cancel the deletion. Tap **Back** when finished deleting spectra.

IMPORTANT *There is no “undo” for this deletion!*

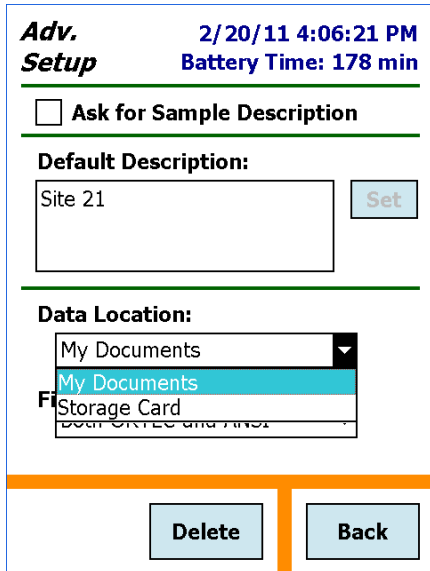

Figure 75. Select the Data Location.

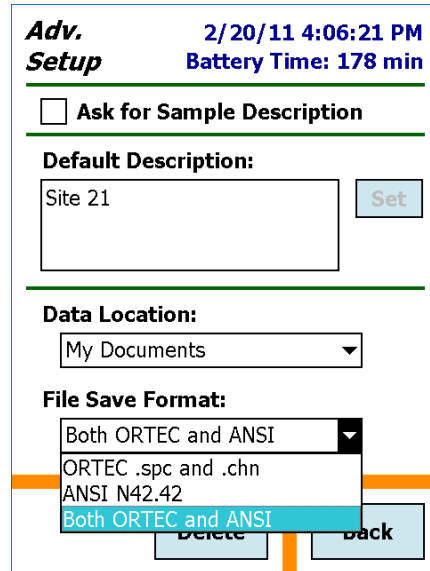

Figure 76. Select the Data Format(s).

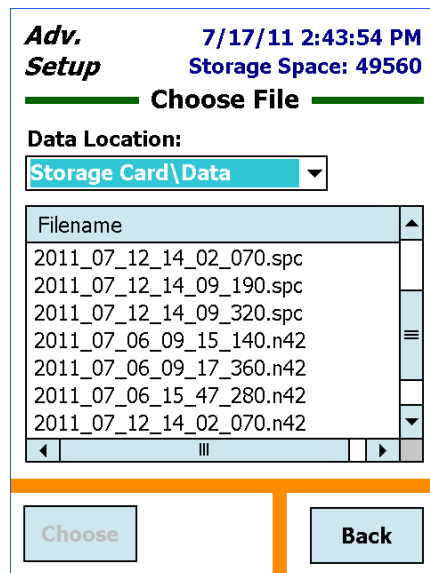

Figure 77. Delete Spectrum Files.

6. FILE TRANSFER TO COMPUTER

The Detective-EX stores Identification Mode spectra in the ORTEC **.SPC** file format, and Search Mode spectra in the simpler **.CHN** format. Once you have downloaded the spectrum files, you can view and analyze them with ORTEC spectroscopy programs such as MAESTRO, Gamma-Vision, and ISOTOPIC. The file transfer method depends on your computer operating system and where your spectrum files are stored on the Detective-EX.

- Spectra stored in the SD card's **Data** folder — The simplest method is to move the card to a computer with a memory card reader and Windows Explorer. Otherwise, transfer files using the Windows Mobile Device Center or ActiveSync as described below.
- Spectra stored in the Detective-EX's **My Documents** folder:
 - **Windows 8/7:** You must download and install Windows Mobile Device Center, as described in Section 6.1, then copy files via Windows Explorer.
 - **Windows XP:** You must download and install Microsoft ActiveSync driver, as described in Section 6.2, then copy files via Windows Explorer.

IMPORTANT Before connecting the Detective-EX to a computer for the first time, install Windows Mobile Device Center or ActiveSync *first*. Otherwise, the unit may not be able to communicate properly with the computer. Contact our Global Service Center if you need assistance.

6.1. Windows 8 and 7

- 1) Download and install the free Windows Mobile Device Center from the Microsoft Download Center. Follow the wizard prompts, restart the computer, then start the Windows Mobile Device Center program.
- 2) Connect the Detective-EX's DATA port to the computer. If this is the first time the Detective-EX has been connected to this computer, Windows 8 and 7 will indicate that the hardware driver has been installed. Windows Mobile Device Center will then take several seconds to communicate with the Detective-EX and indicate the its computer is **Connected** (Fig. 78). If Windows Mobile Device Center cannot connect to the trans-SPEC, see the troubleshooting steps in Section 7.10.
- 3) Click **Connect without setting up your device**. This will prevent the host computer and Detective-EX from automatically synchronizing (i.e., exchanging files). *Do not modify the Program and Services, transfer graphics or music to the trans-SPEC computer, or change the Mobile Device Settings.*

IMPORTANT Remember that the Detective-EX is not to be used for purposes beyond the monitoring tasks described in the user manual, and no changes should be made to the operating system settings.

- 4) Hover over **File Management** to expand its topics, and click **Browse the contents of your device** (Fig. 79).

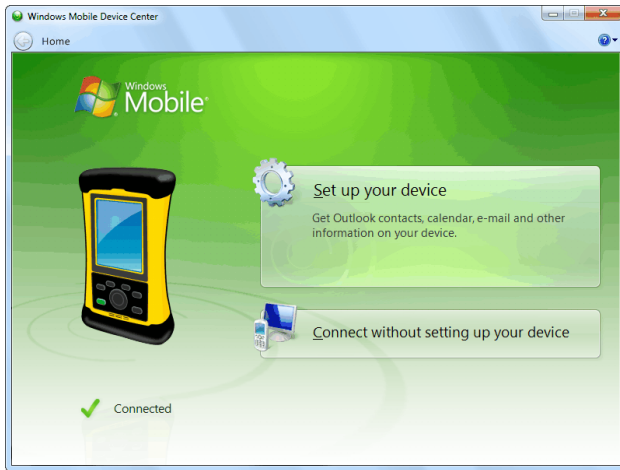

Figure 78. The trans-SPEC is Connected to the Computer.



Figure 79. Choose the File Management Browse Option.

- 5) Windows Explorer will open and the Detective-EX’s computer will be listed as shown in Fig. 80. Stored search and identification files will be located in the SD card’s **Data** folder or in the **My Documents** folder, depending on the location set on the Spectra dialog (see Section ?).
- 6) If your files are stored on the SD card, select the **Storage Card** and open the **Data** folder. If your files are in the **My Documents** folder, select the **Documents** item on the left sidebar. Identification Mode spectra in the **.SPC** format have a “spectrum” icon with a green background. Search Mode files in the **.CHN** format have a “spectrum” icon with a gray background. Text files have the default file icon.

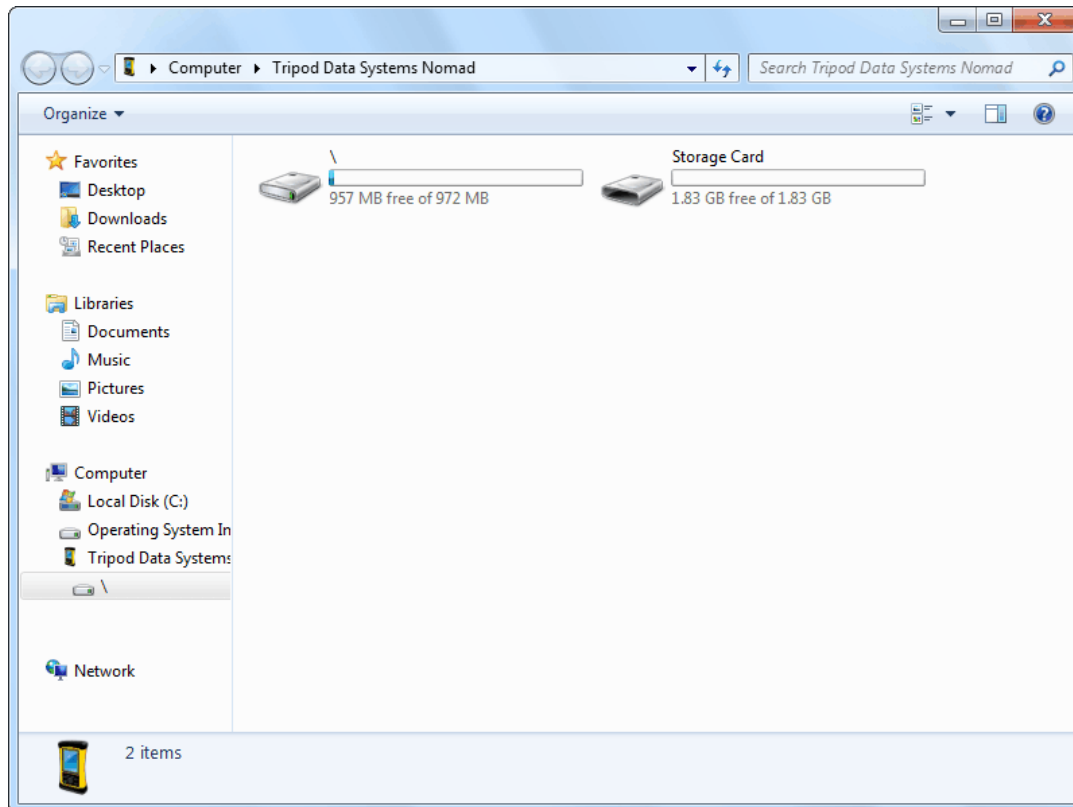

Figure 80. The trans-SPEC Computer's Top-Level File Structure.

6.2. Windows XP

- 1) Download the free ActiveSync v4.5 or higher from the Microsoft Download Center. When download is complete, select **Run**. This will automatically start installation. Follow the wizard prompts and restart the computer.
- 2) Connect the Detective-EX's DATA port to the computer. If this is the first time the unit has been connected to this computer, Windows XP will display a series of "Found New Hardware" messages indicating a mobile device (e.g., the Detective-EX computer) has been detected. The Synchronization Setup Wizard will start. Follow the wizard prompts for a standard partnership according to step (3).
- 3) On the Synchronization Options screen, **unmark ALL checkboxes, scrolling down as needed to ensure all items have been deselected** (Fig. 81). This will prevent the host computer and trans-SPEC from automatically exchanging files.

IMPORTANT Remember that the Detective-EX is not to be used for purposes beyond the monitoring tasks described in the user manual, and no changes should be made to the operating system settings. Doing so could void your warranty.

- Continue with installation as directed. At the end of the wizard, the ActiveSync dialog will indicate the Detective-EX computer is **Connected** (Fig. 82). If ActiveSync cannot connect to the Detective-EX, see the troubleshooting steps in Section 7.10.

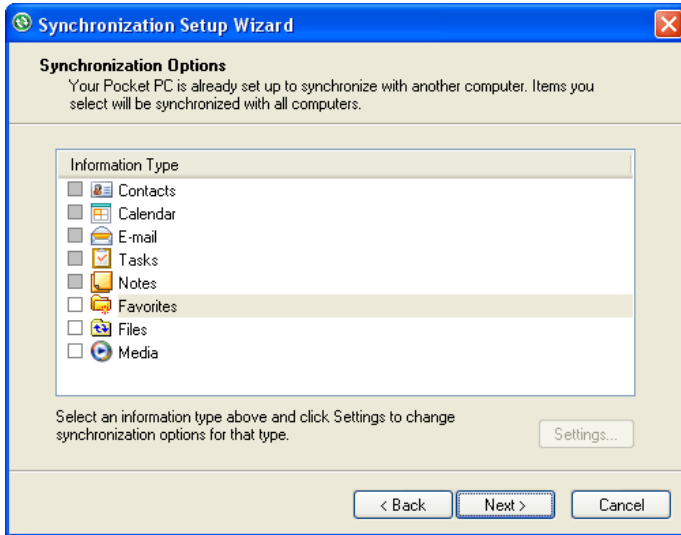

Figure 81. Unmark All Synchronization Options.

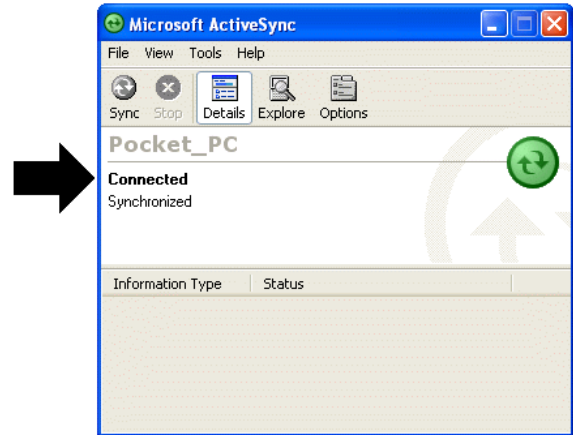

Figure 82. Connection Established.

- You can now click the **Explore** toolbar button in the ActiveSync dialog to open Windows Explorer and view the new connection and its menu tree.

From the host computer, the Detective-EX is displayed as **My Windows Mobile-Based Device** in the **Mobile Device** folder under **My Computer** (Fig. 83). Stored search and identification files will be located in the SD card’s **Data** folder or the **My Documents** folder or, depending on the location set on the Spectra dialog (see Section ?). These locations are indicated by arrows in Fig. 83.

Identification Mode spectra in the **.SPC** format have a “spectrum” icon with a green background. Search Mode files in the **.CHN** format have a “spectrum” icon with a gray background. Text files have the default file icon.

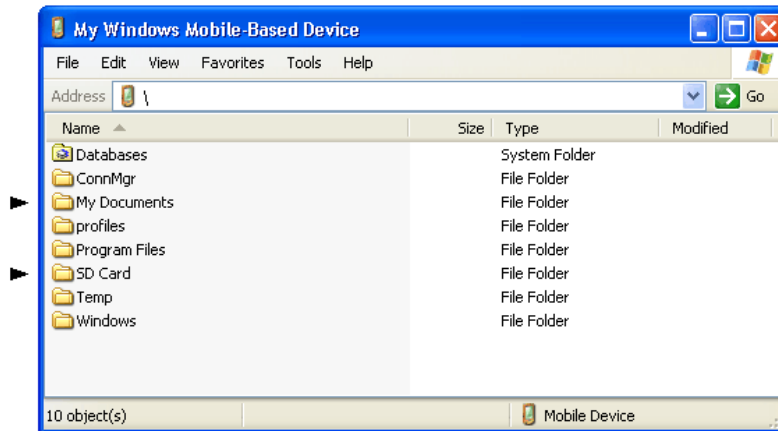

Figure 83. Exploring the Detective-EX Computer’s Files from the ActiveSync Window.

6.3. When File Transfer Is Complete

To return the Detective-EX to standalone service, simply disconnect it from the USB cable and navigate back to the home screen.

[Intentionally blank]

7. TROUBLESHOOTING

7.1. “Error Saving .SPC File” Message

This message is generated if you are saving spectrum and search files to SD card, and (1) the card is removed during a **Save** operation; or the storage medium is defective. If you removed the card, reinsert it and tap **Save** again. If the card is defective, replace it and tap **Save**. If you do not have a replacement card, you must stop the current identification session without saving (in which case, the spectrum will be discarded), go to the Spectra dialog (Section 5.3.3.3), and select a valid location.

If this error occurs when saving files to the computer’s [My Documents](#) folder, contact your ORTEC representative or our Global Service Center.

7.2. If the DetectiveEX Program Stops

The Detective-EX incorporates a computer running the Windows Mobile operating system. Occasionally, the operating system will stop responding to external commands. The power button is located below the display on the lower-right corner of the computer’s bezel. Press and hold the power button for several seconds until the computer shuts down and restarts (the mechanical cooler will continue running). This will reset the operating system and automatically relaunch the [DetectiveEX](#) application.

7.3. If You Drop the Detective-EX

The Detective-EX has been designed to be a rugged instrument, and should survive reasonable levels of mechanical abuse. It has been drop-tested to destruction in development and is known to have a high degree of survivability to “normal” shock and vibration (to a maximum tolerance of 20 g; a shock in excess of this value will void the warranty).

If the instrument is dropped:

- Turn off the MCA electronics (not the cooler) by removing all USB cables and any power cables, then pressing the on/off switch under the protective cover on the top of the display unit. Wait 5 seconds, then turn the unit back on. This should reset any mechanical relays that might have been deactivated by the drop.
- Inspect the exterior for evidence of mechanical damage or distortion.
- *Listen* to the cooler: If you hear any unusual noises (rattling or pinging) emanating from the cooler, contact your ORTEC representative or our Global Service Center.

- Monitor the unit for the next few hours to ensure that it remains **Ready** (indicating that the cooler and bias voltage are functioning properly), calibrates successfully, and correctly identifies the specified calibration source. If, on recalibration, a *large* adjustment is proposed (>0.3% or more), this could indicate a problem.

If the unit fails in one or more of these respects or if one or more hardware diagnostic settings (Section 5.1.1) indicate a hardware failure, contact your ORTEC representative or our Global Service Center for further assistance. *Remember that there are no user-serviceable parts inside the Detective-EX, and opening the case will void the warranty.*

7.4. If the Detective-EX Will Not Turn On

- Connect the Detective-EX to an external power source and attempt to turn the unit on as described in Section 2.8.1. The Detective-EX *must* be connected to an external power source to start the cooler, and the internal batteries cannot cool a warm detector.
- If the battery does not hold a charge, ensure that it is properly installed. If properly installed, the battery must be replaced according to the instructions in Chapter 10.
- If the cooler does not automatically restart, go to the Advanced Setup menu and tap **Turn Cooler On**.

If the problem persists, contact your ORTEC representative or our Global Service Center for assistance.

7.5. If the Docking Station Spontaneously Shuts Down and Restarts

If you attempt to cool the Detective-EX when its internal battery is completely discharged, the high current draw could cause the docking station to shut down and restart approximately once every minute or two. The Detective-EX will not be damaged by this “cycling,” but the unit could take an excessive amount of time to cool and charge. To avoid this, allow the battery to charge for 2 hours before turning on the cooler.

7.6. If the Display is Lost or Posts a “Display Disabled” Message

- Press and hold the on/off button, located on the base of the display, until the shutdown warning screen counts down and the display goes dark. Wait 15–20 seconds, then press

the on/off button to restart the computer. When restart is completed, the **DetectiveEX** program will automatically start and the unit will be ready for use.

For further assistance, contact your ORTEC representative or our Global Service Center.

7.7. If You Forgot the Password

There is no master password. Contact your ORTEC representative or our Global Service Center for assistance.

7.8. Calibration Issues

7.8.1. Calibration Takes Very Long to Complete or Does Not Finish at All

- Make sure your calibration source corresponds to the source selected on the Calibration screen; see step **1** in Fig. 42.
- If the amount of time remaining (see Fig. 43) is lengthy, use a higher-activity calibration source or position the source on the detector endcap.
- If the calibration routine does not complete (continues running beyond one minute), tap **STOP** to abort it, correct the situation, and restart the calibration.

7.8.2. The Centroid, FWHM, or Calibration Adjustment Value Has Changed Dramatically Since the Last Calibration

This is a highly unlikely occurrence. The instrument is an advanced digital design and highly stable when operating correctly.

- If the energy calibration appears highly variable, contact our Global Service Center or your ORTEC representative. Routine changes of the order of 0.05% are to be expected. This might simply be due to counting statistics in the spectrum. A change much larger than this, say 0.5%, bears investigation. Apparent changes in the reported FWHM calibration are most likely to be statistical variations. If the (gain) calibration adjustment value is stable, the unit is functioning properly.
- If large changes in the calibration continue to occur, contact our Global Service Center or your ORTEC representative.

7.9. GPS Issues

7.9.1. Delayed Display of Location Coordinates

If your GPS has not received signals from GPS satellites for >30 days (e.g., if it has not been in use or has been used continuously indoors), it may take 10–15 minutes for the unit to update and begin displaying location information.

7.9.2. “GPS Not Communicating”

This message (see Fig. 31, page 48) is displayed if the **DetectiveEX** software loses contact with the GPS unit. Go to the **GPS Port** list on the Settings screen (Section 5.2.4.3) and make sure the **COM2** port is selected. If the “not communicating” message continues to be displayed after you close the Settings screen, contact your ORTEC representative or our Global Service Center.

7.10. Windows Connectivity Problems

Typically, if ActiveSync or Windows Mobile Device Center cannot find the Detective-EX, it is because the Windows connectivity software was not installed *first*, before the unit was connected to the computer. If the Windows connectivity software has not been installed, when you attach the Detective-EX to the computer for the first time, the “new hardware” bubbles in the lower right corner of the screen will indicate that device driver installation failed.

- Confirm the USB cable is good. If connecting via a USB hub, ensure that it is correctly connected and functioning. Finally, make sure you are connecting to the computer via the DATA port. If this does not resolve the issue, go to the next step.
- In Control Panel, open the Device Manager and check for an **Unknown Device** entry that disappears when you disconnect the Detective-EX from the computer. If such an entry exists, reconnect the Detective-EX, right-click on the **Unknown Device**, select **Uninstall**, and confirm that you wish to uninstall the instrument. Disconnect the Detective-EX from the computer.
- Download and install (or uninstall and reinstall) the ActiveSync or Windows Mobile Device Center software, making sure you have downloaded the correct version; restart the computer; and start the connectivity program.
- Restart the Detective-EX by pressing and holding the On/Off button for 5 seconds, until the screen goes dark and the instrument reboots. When the **DetectiveEX** program has fully reinitialized, reconnect to the computer. You should see one or more “new hardware” bubble messages indicating the Detective-EX was successfully detected.

- If these steps do not resolve the issue, contact your ORTEC representative or our Global Service Center. In the meantime, if your spectrum files are stored in the instrument's **My Documents** folder, you may wish to exit the **DetectiveEX** program, use the computer's Windows Explorer program to copy the spectra to an SD card, then mount the SD card in the computer and transfer the files that way.

7.11. Troubleshooting MAESTRO-Related Problems

7.11.1. MAESTRO Does Not Connect with the Detective-EX

If properly installed and functioning MAESTRO software (or other CONNECTIONS programs) cannot find and communicate with the Detective-EX when it is connected via the CONTROL port:

- Make sure the Detective-EX is turned on and connected to the computer via the CONTROL port.
- Check to see if the Detective-EX display is locked.
- Make sure the USB cable is properly connected to the computer.
- Make sure USB hubs are correctly connected and functioning.
- Check the Master Instrument List on the computer to ensure that the Detective-EX is on the list. If it is not listed, manually run the MCB Configuration program from the Windows Start menu. See the *MAESTRO User's Manual* for detailed instructions on this operation.

7.12. Other Problems with the Detective-EX

Should the Detective-EX exhibit other unusual behavior, confirm that the Regional Settings in the Windows Mobile operating system are set correctly, and restore them if necessary. The Detective-EX is designed to function with Windows Mobile set to the **English (United States)** region and its default values for decimal symbol, digit grouping symbol, and time and date formats, as described below. *Using other than the factory default settings can cause operational problems.*

To check these settings:

- On the third screen of the Advanced menu (Section 5.3.2), tap **Exit**, then confirm that you wish to end the Detective-EX program.
- On the Windows desktop, tap the **Start** square in the upper left corner of the screen, then tap **Settings**.
- In the Settings dialog, tap the System tab, then select **Regional Settings**.
- On the Region tab, select **English (United States)** from the listbox.
- On the Number tab, choose the period (.) for the **Decimal symbol** and the comma (,) for the **Digit grouping symbol**.
- On the Time tab, select *h:mm:ss tt* as the **Time style** and the full colon (:) as the **Time separator**.
- On the Date tab, use *M/d/yy* as the **Short date**, the forward slash (/) as the **Date separator**, and the **Long date** format *dddd, MMMM dd, yyyy*.
- Tap the upper right **OK** circle, then the upper right **X** circle to return to the Windows desktop.
- Restart the Detective-EX as described in Section 2.8.2.

For further assistance, contact your ORTEC representative or our Global Service Center.

8. USING THE DETECTIVE-EX WITH ORTEC SPECTRUM ANALYSIS PROGRAMS

The Detective-EX is intended for completely independent operation, with no computer required. However, when you connect the Detective-EX CONTROL port to a computer running ORTEC spectroscopy applications such MAESTRO or GammaVision, you can use it as a high-performance HPGe spectrometer/digital MCB.

Be sure to install the accompanying versions of CONNECTIONS Driver Update Kit (P/N 797230) and MAESTRO. These contain the most up-to-date drivers for the Detective-EX/DX-100T and other ORTEC hardware. If you have any questions about software/hardware compatibility, contact your ORTEC representative or our Global Service Center. The MAESTRO *User's Manual* contains complete instructions on software installation and configuration of the MCBs attached to your computer. When installing CONNECTIONS, choose the **USB-Based Instruments** selection to install the correct driver for the Detective-EX/DX-100T.

IMPORTANT

When both the Detective and trans-SPEC applications are installed on your identifier, *the unit's operation depends on the application running when it is connected to the analysis computer.* If running the Detective application, the allowable changes to hardware settings within MAESTRO are restricted. This includes the gain, rise time, calibration, and other settings that will affect the location of gamma peaks (see Section for the allowable hardware settings). When you disconnect the identifier's CONTROL port from the computer, the unit automatically restores all factory settings for the standalone Detective.

If the unit is running the trans-SPEC application, almost all hardware settings are adjustable (see the trans-SPEC manual for complete details on the allowable hardware settings). Any changes made in MAESTRO remain in effect when you disconnect from the computer and return to standalone trans-SPEC operation.

8.1. Connecting the Detective-EX to a Computer

To enter MCA Mode, simply connect the Detective-EX to the computer via the rear-panel CONTROL port. Within a few seconds the Detective-EX screen will change to the display shown in Fig. 84 and all touchscreen features will be disabled. The unit can then be used as a high-performance MCB in MAESTRO, etc.

The first time this Detective-EX is connected to a particular for use as an MCB, follow the installation instructions in Chapter 6 for the host computer's operating system.

The final step is to run the **MCB Configuration** program according to the instructions in the MAESTRO *User’s Manual* to build **Master Instrument List** of all ORTEC MCBs accessible to the computer.

To monitor the battery time remaining from within MAESTRO, go to the Status tab under **Acquire/MCB Properties...**

To return the Detective-EX to standalone operation, simply disconnect from the computer. In a few seconds, the touchscreen will become active in the normal standalone mode. If, after unplugging the USB cable, the instrument does not return to the Detective-EX interface, reconnect the cable, wait 12–15 seconds, and disconnect. Repeat as needed until the display unlocks.

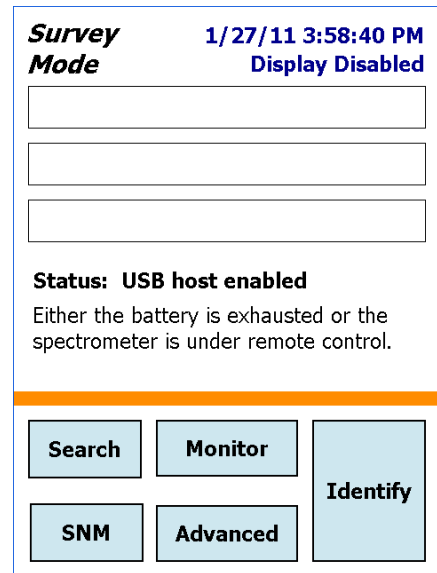

Figure 84. Connected to Computer Via CONTROL Port.

NOTE MAESTRO and other ORTEC spectroscopy applications have a **Lock/Unlock Detector** command to prevent unauthorized users from changing detector settings, starting and stopping data acquisition, and clearing the detector memory. This locking command functions separately from the Detective-EX password. If the Detective-EX is password-locked within MAESTRO, you can still use it in the field without knowing the password; however, you cannot reconnect it to a computer and erase its memory. In addition, the next time you use it in MCA Mode with MAESTRO, it will still be locked. *Also note that if the Detective-EX’s display is locked, it cannot communicate with a computer (Section ?).*

8.2. Quantitative Analysis of Detective-EX Spectra in GammaVision and ISOTOPIC

The Detective-EX can be used to collect data for quantitative analysis, either as a standalone field instrument or a benchtop MCB connected to a computer. In both usage modes, the data are stored as **.SPC**-format spectrum files. The **.SPC** files can then be quantitatively analyzed on a computer using GammaVision or ISOTOPIC.

Note, however, that the Detective-EX is not designed to store efficiency information in the **.SPC** files it creates. Therefore, for quantitative determinations, special attention is needed to prepare the calibration (**.CLB**) file so that GammaVision or ISOTOPIC will add the efficiency information during processing.

To prepare this calibration file, load a Detective-EX calibration spectrum into GammaVision or ISOTOPIC. Use the software application's **Calibration Wizard** to obtain the additional efficiency calibration, keeping the existing energy calibration. After the efficiency calibration is computed, save the complete set of calibrations as a **.CLB** file.

To add the efficiency information to an existing **.SPC** file (typically from a standalone Detective-EX):

- Transfer the **.SPC** file from the Detective-EX to the computer (see Chapter 6).
- Recall the **.SPC** file in GammaVision or ISOTOPIC.
- Load the **.CLB** file containing the proper efficiency information. This can be done either with the application's **Recall Calibration** command; or by specifying the **.CLB** file as the calibration override in the GammaVision analysis options (**.SDF**) file or the ISOTOPIC configuration.
- Save the **.SPC** file with or without further analysis.

NOTE If the **.CLB** file is specified in the GammaVision **.SDF** file or ISOTOPIC configuration, the **.An1** file generated during analysis will contain the proper calibration information but the original **.SPC** file (without the efficiency information) will not change.

To load the efficiency information before acquiring a new spectrum (with the Detective-EX attached to a computer):

- Load the **.CLB** file either with the **Recall Calibration** command; or by specifying the **.CLB** file as the calibration override in the GammaVision **.SDF** file or ISOTOPIC configuration.
- Acquire a new spectrum and save it in **.SPC** format.

8.3. Detective-EX MCB Properties in MAESTRO

This section discusses the hardware setup dialogs you will see within MAESTRO when you use the **MCB Properties...** command on the **Acquire** menu. The MCB Properties dialog contains all of the instrument controls including acquisition presets, high voltage, hardware status indicators, and amplifier settings. As noted in the introduction, except for the presets, the Detective-EX acquisition parameters are factory-set and cannot be adjusted. To view the hardware parameters,

and Identification Mode messages for spectra downloaded from the Detective-EX, move from tab to tab. Click on **Close** when finished.

Note that as you enter characters in the data-entry fields, the characters will be underlined until you move to another field or until 5 seconds have lapsed since a character was last entered. During the time the entry is underlined, no other program or computer on the network can modify this value. The changes you make on most property tabs take place immediately. There is no cancel or undo for the dialog.

NOTE In MAESTRO, the **Download Spectra** and **View ZDT Corrected** commands on the **Acquire** menu and the **Smooth** and **Strip** commands on the **Calculate** menu are disabled for this instrument.

8.3.1. Amplifier

Figure 85 shows the Amplifier tab. This tab displays the settings for the **Coarse** and **Fine Gain**, which are factory preset and cannot be changed. The fine gain changes when the unit is recalibrated.

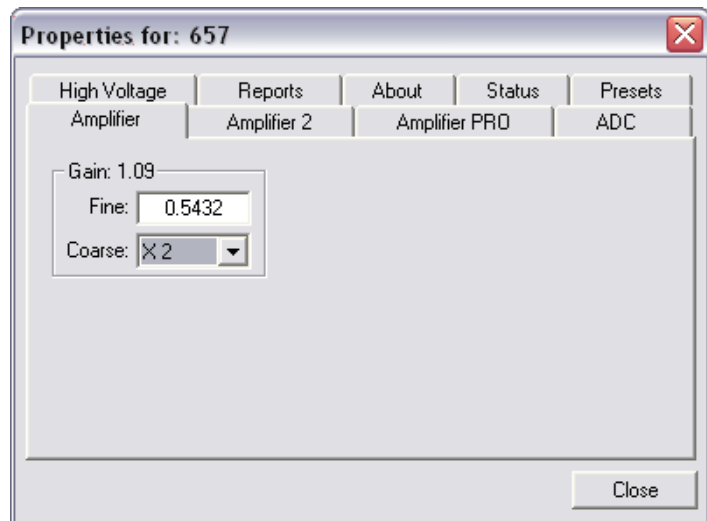

Figure 85. Detective-EX Amplifier Tab.

8.3.2. Amplifier 2

Figure 86 shows the Amplifier 2 tab, which displays the fixed **Rise Time** and **Flattop Width** settings. You can also use the **InSight** Virtual Oscilloscope™ mode to view the digital signal processor's actual sampled waveform on a reference graticule; however, the shaping settings cannot be adjusted.

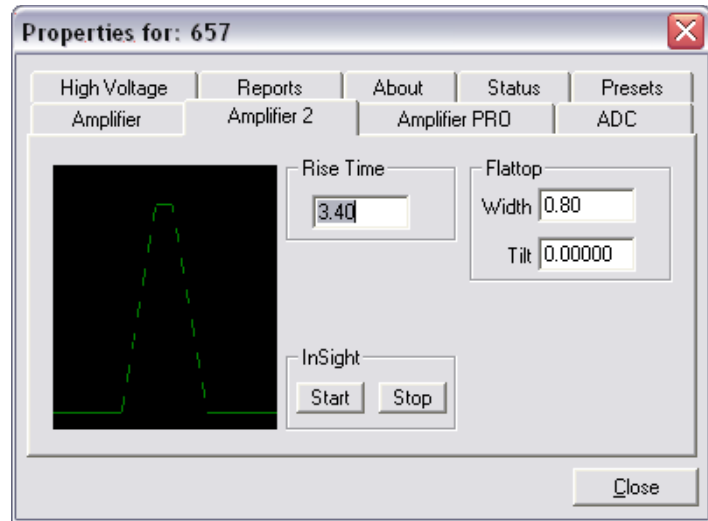

Figure 86. Detective-EX Amplifier 2 Tab.

8.3.3. Amplifier PRO

This tab (Fig. 87) displays the control for the Low Frequency Rejector (LFR)¹⁵ feature, a digital filter that corrects the pulse output signal for cooler-induced microphonics). It cannot be disabled.

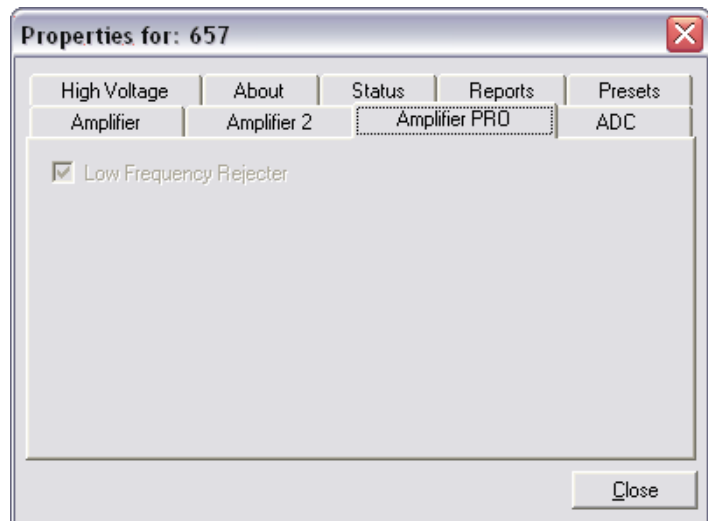

Figure 87. Detective-EX Amplifier PRO Tab.

¹⁵Patent pending.

8.3.4. ADC

This tab (Fig. 88) allows you to monitor the current **Real Time**, **Live Time**, and **Count Rate**. In addition, you can view the fixed **Conversion Gain** and the **Lower** and **Upper Level Discriminator** settings.

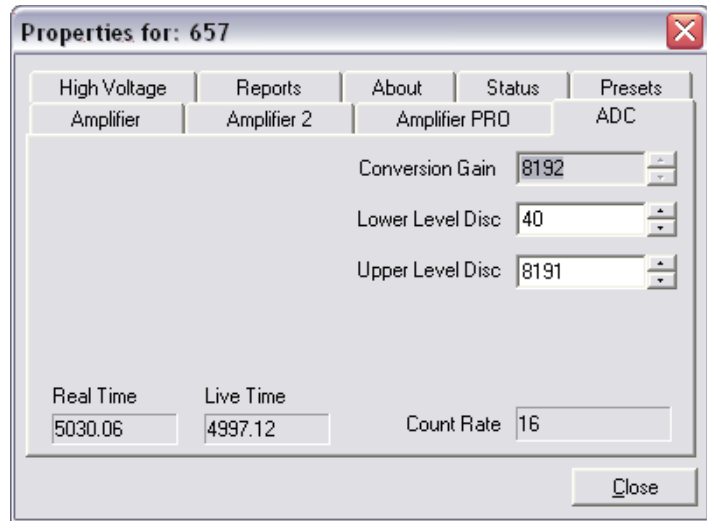

Figure 88. Detective-EX ADC Tab.

8.3.5. High Voltage

Figure 89 shows the High Voltage tab, which allows you to monitor the **Actual** bias. You cannot adjust the bias voltage or turn it on and off; these functions are factory set.

The **Shutdown** is fixed as **SMART**¹⁶ and cannot be changed.

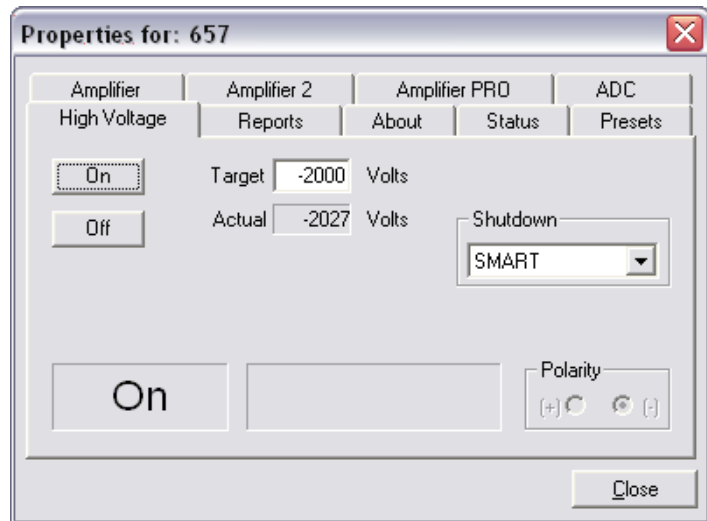

Figure 89. Detective-EX High Voltage Tab.

¹⁶A reference to our SMART-1™ detector technology. For more information on SMART-1, see the ORTEC catalog or visit www.ortec-online.com.

8.3.6. Reports

This tab (Fig. 90) displays the reports available for the current live spectrum or spectrum file, including the ID, Found Nuclides, Suspect Nuclides, Top Lines, and (for instruments so equipped) GPS reports. You must be running MAESTRO or other ORTEC spectroscopy applications.

When using the Detective-EX as an MCA controlled by the host computer, be sure to click the **Refresh** button for each report to ensure you are seeing the most current data.

For more information on the contents of these reports, see Section 5.1.6.

8.3.7. About

This tab (Fig. 91) displays hardware and firmware information about the Detective-EX as well as the data **Acquisition Start Time** (Sample description is not used). In addition, the **Access** field shows whether the MCB is currently locked with a password by MAESTRO. **Read/Write** indicates that the MCB is unlocked and **Read Only** means it is locked. See the note concerning passwords on page 82, at the end of Section 8.1.

Use the **Firmware Revision** field to determine both the type of Detective-EX (regular or -100 model, with or without neutron detector) and firmware version. This parameter is formatted *DETX- nnn* , where X is *C* for the regular Detective-EX, *D* for the Detective-EX-100, *F* for the regular Detective-DX, and *G* for the Detective-DX-100; and nnn is the firmware version. In the accompanying illustration, *DETF-304* indicates a regular Detective-DX

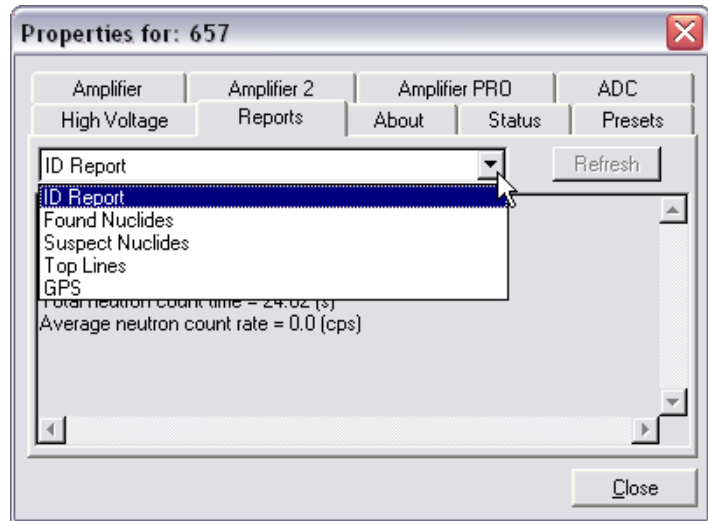

Figure 90. Detective-EX Reports Tab.

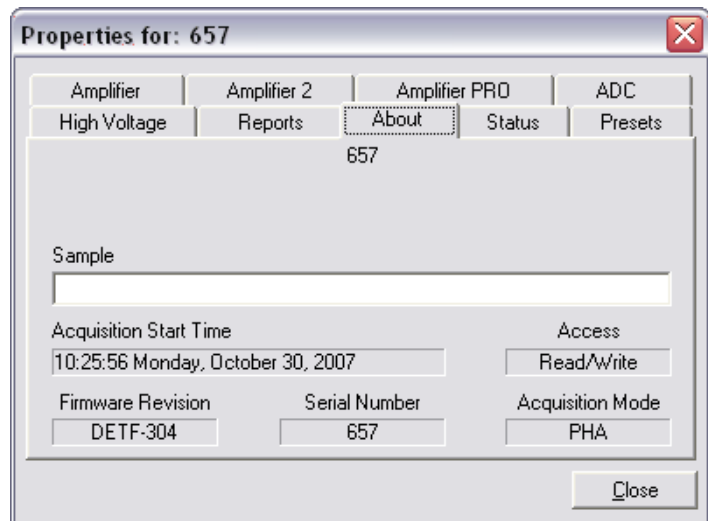

Figure 91. Detective-EX About Tab.

running firmware V3.04. You can also use the About tab to view this information for .SPC format spectra downloaded from the Detective-EX.

8.3.8. Status

Figure 92 shows the Status tab. Ten parameters are continuously monitored in real time. Satisfactory status is reported as **OK** or as a numerical value. A failure is reported as **ERR** or a descriptive message. Use the listboxes to select any six parameters to be displayed simultaneously on the Status tab. You can change the selected parameters at any time.

The monitored parameters are:

- **Detector State of Health** — reported as **OK** or **ERR**.
- **Gamma Dose Rate** — reported in $\mu\text{Sv/h}$, and indicating whether this reading was made with the detector (**Ge** for low dose rates) or the Geiger-Müller tube (**GM** for high dose rates). See **Gamma Dose-Rate Determination**, page 92, for further discussion of the two dose-rate meters.
- **Detector Temperature** — reported as **OK** or **ERR**.
- **Battery Voltage** — reported in volts.
- **Battery Time Remaining** — in minutes.
- **Cooler Body Temperature** — **OK** or **ERR**.
- **Cooler Drive Voltage** — **OK** or **ERR**.
- **Cold-Tip Temperature** — **OK** or **ERR**.
- **HV Bias** — in volts.
- **ID Table Version** — the identification table version and release date.

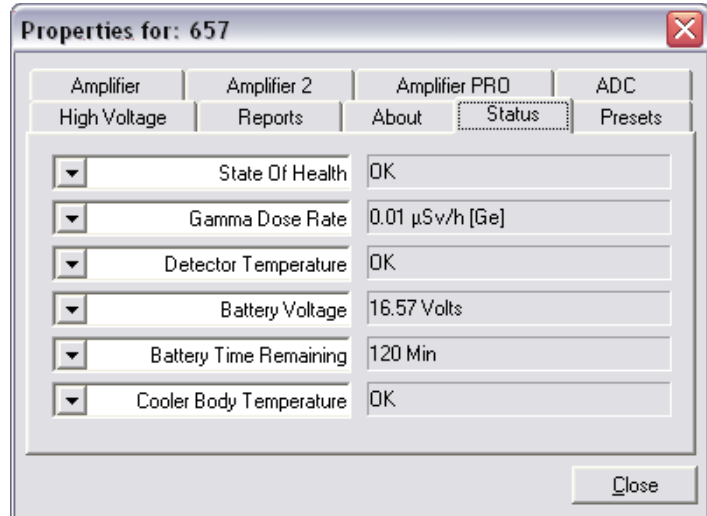

Figure 92. Detective-EX Status Tab.

To resolve status problems, refer to the troubleshooting list in Chapter 7. For further assistance, contact your ORTEC representative or our Global Service Center.

8.3.9. Presets

Figure 93 shows the Presets tab. The presets can only be set when the Detective-EX is not acquiring data (during acquisition the preset field backgrounds are gray indicating that they are inactive). You can use any or all of the presets at one time. To disable a preset, enter a value of zero. If you disable all of the presets, data acquisition will continue until manually stopped.

NOTE The presets on this tab do not affect the Detective-EX when the instrument is operating in standalone configuration

(disconnected from the computer). When operating as a standalone identifier all presets are cleared. When the **Identify** button is pressed, the Detective-EX will always continue to take data until the **Stop** button is pressed.

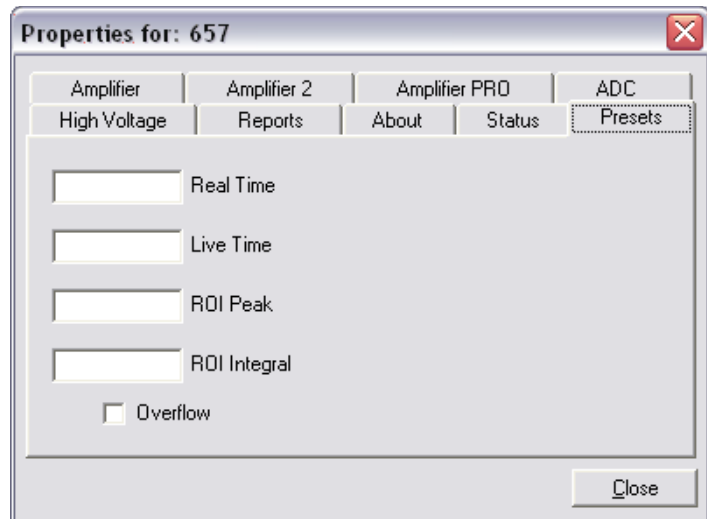

Figure 93. Detective-EX Presets Tab.

When more than one preset is enabled (set to a non-zero value), the first condition met during the acquisition causes the MCB to stop. This can be useful when you are analyzing samples of widely varying activity and do not know the general activity before counting. For example, the **Live Time** preset can be set so that sufficient counts can be obtained for proper calculation of the activity in the sample with the least activity. But if the sample contains a large amount of this or another nuclide, the dead time could be high, resulting in a long counting time for the sample. If you set the **ROI Peak** preset in addition to the **Live Time** preset, the low-level samples will be counted to the desired fixed live time while the very active samples will be counted for the ROI peak count. In this circumstance, the **ROI Peak** preset can be viewed as a “safety valve.”

The values of all presets for the currently selected MCB are shown on the Status Sidebar. These values do not change as new values are entered on the Presets tab; the changes take place only when you **Close** the Properties dialog.

Enter the **Real Time** and **Live Time** presets in units of seconds and fractions of a second. These values are stored internally with a resolution of 20 milliseconds (ms) since the MCB clock increments by 20 ms. Real time means elapsed time or clock time. Live time refers to the amount

of time that the MCB is available to accept another pulse (i.e., is not busy), and is equal to the real time minus the dead time (the time the MCB is not available).

Enter the **ROI Peak** count preset value in counts. With this preset condition, the MCB stops counting when any ROI channel reaches this value unless there are no ROIs marked in the MCB, in which case that MCB continues counting until the count is manually stopped.

Enter the **ROI Integral** preset value in counts. With this preset condition, the MCB stops counting when the sum of all counts in all channels for this MCB marked with an ROI reaches this value. This has no function if no ROIs are marked in the MCB.

Marking the **Overflow** checkbox terminates acquisition when data in any channel exceeds $2^{31}-1$ (over 2×10^9) counts.

9. SPECIFICATIONS¹⁷

System Conversion Gain The Detective-EX/DX operates at a conversion gain of 8192 channels.

Shaping-Time Constants

- Rise time: 3.4 μ s, fixed.
- Flattop: 0.8 μ s width, fixed.

Dead-Time Correction Extended live-time correction according to Gedcke-Hale method.¹⁸ Accuracy: area of reference peak changes $<\pm 3\%$ from 0 to 50000 cps.

Linearity

- Integral Nonlinearity: $<\pm 0.025\%$ over top 99.5% of spectrum, measured with a mixed source (⁵⁵Fe at 5.9 keV to ⁸⁸Y at 1836 keV).
- Differential Nonlinearity: $<\pm 1\%$ (measured with a BNC pulser and ramp generator).

Overload Recovery At maximum gain, recovers to within 2% of rated output from $\times 1000$ overload in 2.5 non-overloaded pulse widths (measured using our InSight™ Virtual Oscilloscope).

Pulse Pileup Rejector Automatically set threshold. Pulse-pair resolution typically 500 ns.

Stored-Spectrum Memory An unlimited number of spectra can be stored on removable SecureDigital or CompactFlash memory cards. The number of spectra stored on an individual card depends on the capacity of the card.

Low Frequency Rejector (LFR) Filter¹⁹ The digital signal processor incorporates ORTEC's exclusive LFR filter, designed to reduce microphonic and low-frequency periodic noise (if present) from germanium detector output signals, thereby producing significant improvement in spectral resolution. The LFR is specifically beneficial in systems cooled by mechanical coolers, which are known to often contribute microphonic noise to the spectrum (thereby degrading spectral resolution). The LFR is also capable of reducing any periodic noise signal resulting from surrounding electronics and equipment or ground loops.

¹⁷Subject to change without notice.

¹⁸Ron Jenkins, R. W. Gould, and Dale Gedcke, *Quantitative X-Ray Spectrometry* (New York: Marcel Dekker, Inc.), 1981, pp. 266–267.

¹⁹Patent pending.

Cooler High-reliability, low-power Stirling cooler. Dual-piston design, 1 W nominal lift at 100K. The cooler is designed for continuous operation and cooler life is expected to exceed 50000 hours. Initial cooldown time depends on ambient temperature, but is typically <12 hours at 25°C.

Gamma-Ray Detector Internal, coaxial HPGe detector. P-type high-purity germanium. Detective-EX: 50 mm diameter × 30 mm deep (nominal). Detective-EX-100: 65 mm diameter × 50 mm deep (nominal).

Neutron Detector Internal, 4 each, ³He tubes, 1.3 cm × 10 cm active length, 20 atm, stainless steel body, RS-P4-0404-214, inside 2.5 cm × 18 cm × 14 cm moderator.

Internal Compensated Geiger-Müller Tube LND 71322 Geiger Müller tube. GM tube specifications are available on request.

Gamma Dose-Rate Determination

Visual overrange indication and continuous audible alarm at dose rates >10000 µSv/h.

The Detective-EX uses two detectors to determine the gamma dose rate over a wide range from <0.05 µSv/h to >10000 µSv/h, a dose-rate range of around six decades. For low dose rates, below ~20 µSv/h, the dose rate is determined from the Ge detector spectrum. For dose rates above this value, the internal compensated GM tube is used. The Detective-EX switches between the two automatically.

For radiation fields from extended sources (e.g., from a container full of NORM) or far-field point sources (>1 ft [0.3 m] from the instrument), the precise location of the detector in use is not important. When point sources are close to the instrument, the detector readings might not be in agreement because they are in different places within the instrument, and the dose rate is varying rapidly with position. It will be different at these two detector locations.

NOTE The dose rate function in the Detective-EX should not be considered as adequate for accurate dosimetry purposes. Its primary purpose is to protect the user of the Detective-EX from high radiation fields.

If you must test the dose-rate measurement capability with a point source, especially at close range, it is important to know the reference points of the instrument detectors, since test procedures such as ANSI or IAEA prescribe use of point sources at specified distances from the reference point of the instrument. For the Ge detector, the reference point is the geometric center of the Ge detector endcap disk (see Fig. 94). For the GM and neutron detectors, the reference point is shown in Fig. 94 and is marked on the case of the instrument.

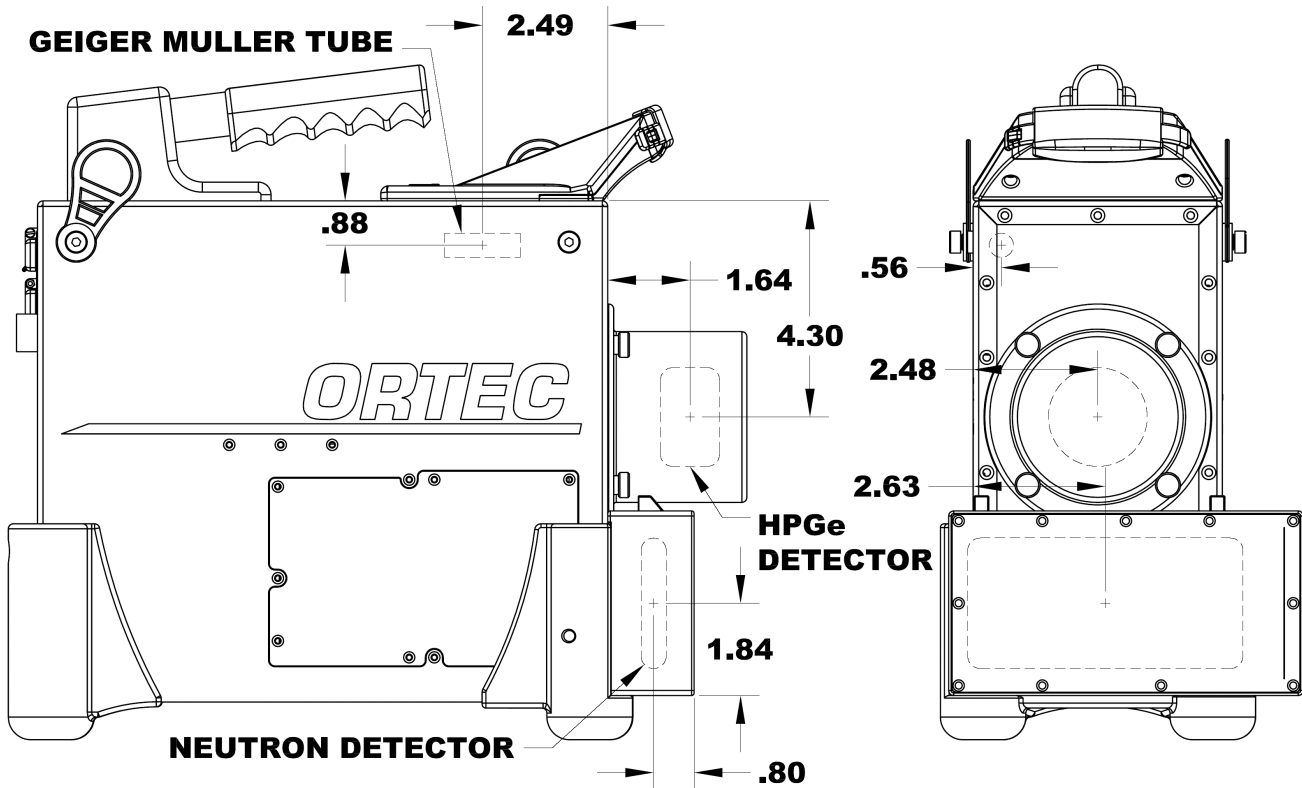

Figure 94. Reference Points for the HPGe and Neutron Detectors and the Geiger-Müller Tube (all measurements in inches).

GPS Internal NMEA-compliant, WAAS-capable.

Wireless Communication Optional integrated IEEE 802.11b wireless hardware; third-party software can be used to implement this option. See the ORTEC technical note *Wireless Remote Operation With SOTI's Pocket Controller Software (P/N 932735)*.

Presets Multiple presets can be set within MAESTRO for any or all of the following:

- **Real Time** Stops data collection when the real time reaches this value (in increments of 1 s).
- **Live Time** Stops data collection when the live time reaches this value (in increments of 1 s).
- **ROI Integral** Integral count stops data collection when the sum of all ROI channels reaches this value.

- **ROI Peak** Peak count stops data acquisition when any ROI channel reaches this value (maximum value of $2^{32}-1$ counts [4×10^9]).
- **Data Overflow** Terminates acquisition when data in any channel exceeds $2^{31}-1$ (2×10^9) counts.

9.1. Electrical and Mechanical

Dimensions Maximum overall dimensions including handle, Ge detector endcap, neutron detector and shock absorbers.

Detective-EX-100T: 39.4 cm L × 18.3 cm W × 34.9 cm H (15.5 in. × 7.2 in. × 13.1 in.)

Detective-DX-100T: 39.4 cm L × 16.3 cm W × 34.9 cm H (15.5 in. × 6.55 in. × 13.75 in.)

●Weight

Detective-EX-100T: 12 kg (26.3 lb).

Detective-DX-100T: 11.3 kg (24.4 lb).

Maximum Shock Tolerance 20 g. An accelerometer inside the instrument tracks the maximum shock to which the Detective-EX has been subjected, and a shock in excess of 20 g will void the warranty.

Ambient Operating Environment 0 to +40°C, at a relative humidity <90% at 35°C, non-condensing.

Input Power 10 V to 17 V dc 30 W or from auto-sensing ac-powered battery charger.

External Power DC input and battery charge input, MS3112E12-10-S or Bendix PT02E-12-10S connector.

Internal Battery Rechargeable, nominal 14.4-V lithium-ion battery pack. Contact ORTEC for the appropriate replacement kit. Charging circuitry and battery management circuitry internal to the docking station or PAC-II. Battery lifetime 3–5 years. Access door in right side panel of case. The compartment is semi-sealed and protects against penetration of dirt and moisture. See Chapter 10 for instructions on replacing the battery.

Battery Life >3 hours at 25°C when HPGe detector is cold. Battery life can be extended indefinitely by the use of optional, external battery belt. The unit is expected to be kept running once cold.

Note that the internal battery charge is not sufficient to start the Detective-EX cooler or cool a warm detector; external power is required. In addition, an exhausted internal battery should be charged for 2 hours before the Detective-EX is cooled using external power. Cooler startup without external power and/or with an exhausted internal battery can cause operational anomalies. For other startup issues, see Sections 7.5 and 7.6. Also note that using an automobile battery to cool the detector could significantly discharge the auto battery.

CE Conforms to CE standards for radiated and conducted emissions, susceptibility, and low-voltage power directives.

9.2. Connectors

DATA Rear-panel USB connector, with dust cover, for computer communications.

CONTROL Rear-panel USB connector, with dust cover, for MCA communications.

INPUT POWER Rear-panel external power input, with dust cover, 12–17 V dc, 60 W, or from battery or auto-sensing ac-powered battery charger.

Headphones () Rear-panel female connector, with dust cover, accepts standard male headphone jack. Headphone volume controllable from the Detective-EX button pad. Note that the audible high-dose-rate alarm sounds whether or not headphones are connected to the Detective-EX. This alarm is not routed through the headphones and its volume is independent of the headphone volume setting.

9.3. Docking Station

Calibration Source (if present) Solid, sealed, $\sim 0.25\text{-}\mu\text{Ci}$ (9250-Bq) ^{137}Cs calibration source housed in the source holder on the front of the docking station. This source is exempt under U.S. and European regulations and is only supplied pre-installed by ORTEC (not separately). We do not recommend that it be removed, nor will ORTEC accept any responsibility whatsoever for its removal.

POWER IN Keyed, front-panel connector attaches to the mains-powered dc power supply.

Detective-EX Power Supply Cable Integral rear-panel cable terminating in MS3112E12-10-S or Bendix PT02E-12-10S connector, center contact positive, attaches to the Detective-EX INPUT POWER connector to supply external power and charge the Detective-EX internal battery.

9.4. PAC-II Power Adapter/Charger

POWER IN Keyed, rear-panel connector attaches to a +12–15 V dc power supply, 9 A maximum.

AC Input Rear-panel connector, 115–230 V ac, 50–60 Hz, 250 VA maximum.

OUTPUT Integral front-panel cable terminating in MS3112E12-10-S or Bendix PT02E-12-10S connector, center contact positive, attaches to the Detective-EX INPUT POWER connector to supply external power and charge the Detective-EX internal battery.

Charger Status LEDs Front-panel red and green LEDs. When the Detective-EX's internal battery is charging, the red indicator is continuously lit. The red indicator flashes if you disconnect the unit before its battery is fully charged, or if it is connected but the internal battery is faulty. When the battery is fully charged, the green indicator turns on and the red indicator turns off.

9.5. Computer Prerequisites

In addition to completely independent, standalone operation, the Detective-EX can also be operated as a benchtop MCB, in conjunction with ORTEC spectroscopy applications such as MAESTRO, by connecting it to any computer running Windows 8, 7, or XP Professional SP3.

9.6. Shipping the Detective-EX

To avoid damaging the cooler and, where applicable, to comply with transportation regulations, be certain to turn the cooler off before shipping the Detective-EX. To do this, tap **Advanced** in the Survey Mode dialog, then **Turn Cooler Off**. The unit can be shipped as soon as the cooler is turned off. There is no need to wait until the detector warms up.

9.7. Long-Term Shutdown/Storage

CAUTION

This instrument should be cooled and brought to operational status for at least 48 hours every month. Failure to do this may result in degraded performance or cooling system failure.

This instrument uses a Sterling cycle refrigerator and all-metal-sealed cryostat designed for long operational life. The vacuum integrity inside the cryostat is maintained by “getters” which scavenge traces of residual material when cold, and by an ion pump which operates when the

instrument is powered up. These two techniques maintain the system vacuum in peak condition during normal use. A good vacuum yields rapid cooldown, and ensures operation at the high end of the instrument's operating temperature range.

Over time, in any cryostat system, residual contaminants can be released from the materials inside the evacuated cryostat by a process called *outgassing*.²⁰ It has become apparent that, in extended storage, the vacuum in our mechanically cooled identifiers may degrade to the point that, on trying to restart, the gas load inside the cryostat is too high and the unit fails to cool. The remedy is reasonably straightforward, if inconvenient: a "pump and bake" of the instrument is required at an ORTEC service center. Fortunately, you can easily avoid this problem:

We strongly recommend that instruments used only occasionally be turned on once a month, fully cooled to Ready status, and allowed to run for at least 48 hours. Doing this starts the ion pump and activates the internal getters, ensuring that the vacuum is maintained in good condition.

As well as maintaining the vacuum, this procedure keeps the system battery "topped up" and also provides peace of mind that the system will cool when required.

²⁰This is not to be confused with a vacuum leak, although both result in a degradation of the vacuum.

[Intentionally blank]

10. CHANGING THE INTERNAL BATTERY

The typical service life of the Detective-EX internal battery is 3–5 years. When the internal battery no longer retains a charge, it must be replaced with ORTEC Part No. 798780. This is a straight-forward operation that takes just a few minutes, so the detector does not significantly warm up during the procedure. When connected to external power such as the docking station, the new battery will typically reach full charge within 2–4 hours.

For more information, contact your ORTEC representative or our Global Service Center.

To change the battery:

- 1) Turn off the cooler and the Detective-EX electronics by reversing the instructions in Section 2.8.2.
- 2) Figure 96 shows the battery hatch on the side panel. Remove the five (5) Phillips or Torx® T10 screws from the hatch (there is no sixth screw under the black rubber “foot”). Gently pry up one end of the hatch, then slip it from behind the rubber foot and expose the battery.

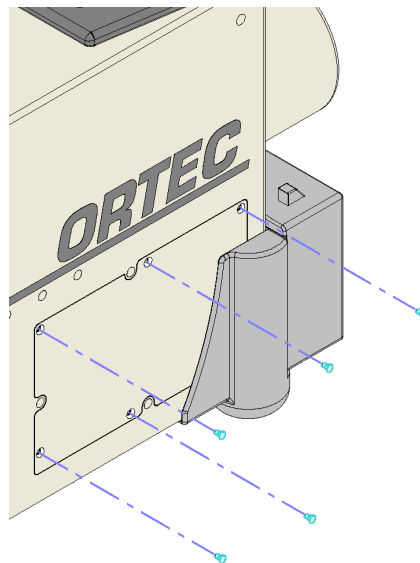

Figure 96. Battery Hatch Fastened With Five Screws.

- 3) Open the tie that holds the battery in place. Note the orientation of the battery and connector as you disconnect and remove the old battery. The connecting wire for the new battery (Fig. 97) should feed from the front of the battery compartment, across the top edge of the battery pack (the edge closest to the top of the instrument), then toward the back of the compartment. Close the tie around the new battery.
- 4) Reverse Steps 2 and 3 to replace the hatch.
- 5) Connect the Detective-EX to external power. (Remember that the cooler cannot be restarted from the internal battery.)
- 6) Restart the Detective-EX, turn on the cooler, and wait for the instrument status to change to **Ready**.
- 7) Return the old battery to ORTEC for recycling.



Figure 97. Internal Battery Pack and Connector.

11. CALIBRATION SOURCE STATEMENT

The quantity of radioactive material contained in this product is extremely small and presents no known radiation hazard. However, it is always good practice to minimize exposure by following the basic radiation principles of time, distance, and shielding. The solid sealed source in this instrument requires no special handling.

Exempt quantity licensed products containing radioactive material should be used only as intended by the manufacturer and in accordance with the instructions provided. All radioactive materials should be securely stored when not in use.

This product may be disposed of in regular waste without regard to the radioactive content providing the customer is not a specific licensee and all radiation symbols have been removed or defaced. If the customer receiving the exempt quantity is a specific licensee, then the customer is subject to the requirements of 10 CFR Part 20 in areas where 10 CFR 30.18 is silent (e.g., waste disposal).

This product conforms to the conditions and limitations specified in 49 CFR 173.424 for radioactive material, excepted package-instruments or articles, UN2911.

[Intentionally blank]

INDEX

Administrator Mode	
advanced setup	47
hiding the spectrum display	62
password	61
Alarms	
dose-rate and count-rate	64
MOVE BACK	22
RDD	46, 64
Audio settings (clicker)	65
Background measurements	59
final (mandatory) step in calibration	25
ID and Monitor Modes disabled	19
invalid background	19
minimum data collection time	52, 59
performing the background measurement	52
required after manual calibration	51
Battery	16, 17
cannot cool detector	21, 49
charge status	14, 15
power source indicator	17, 22
replacing	18, 99
Calibration check	23, 49
auto-calibration	57
manual	49
new background required	25, 51
source	14
troubleshooting	77
user-defined sources	57
Calibration source	14, 24
user-defined	57
Cautions	18
Charger bases	
cautions	18
docking station	14
power adapter/charger	15
Clicker	
audio settings	65
Connecting to a PC	81
using MAESTRO	83
Connections	
auto battery adapter cables	16
Detective-EX	12
docking station	14
power adapter/charger	15
setup and power-up	20
Cooler	
cautions	18
detector warmup	96
power sources	16
power-up	21
restarting	21
shipping	96
shipping preparations	19
shock tolerance	18
shutdown for brief periods	49
shutdown for long periods/storage	18, 96
startup	49
Detective-EX	
ADC setup	86
amplifier settings	84, 85
carrying strap	13
docking station	95
features, illustrated	10
GPS	62
high-voltage setup	86
operating cautions	18
power adapter/charger	96
power-up	76
presets	89
setup	20
shock tolerance	18
software and firmware versions	56
status screen	48
temperature and humidity specifications	18
use as conventional MCA	79
Display Mode	35
hiding the spectrum display	62
Docking station	
cautions	18
connectors	14
features	14, 15
indicators	14, 15
placement	14, 15
power	14, 16
setup	20
Dose- and count-rate limits	30, 64

Dose-rate detector		Quantitative analysis	82
reference points	93	RDD Detected message	46
Exit	66	Reference point	93
File transfer to PC	69	Remote screen	66
Gamma count rate meter	29	Reports	
Gamma dose rate	30	found nuclides	33, 54
dose-rate units	64	GPS location data	55
rate meter display	29	ID report	54
setup and defaults	64	suspect nuclides	33, 55
GPS (global positioning)	4	top lines (most intense)	34, 55
GPS report	55	viewing in MAESTRO	87
latitude/longitude indicator	29	viewing stored spectra and reports	52, 53
troubleshooting	78	Restricting access to settings	27, 61
Hardware status	47	Search Mode	2
Identification Mode		“strip chart” (.CHN and .N42) files	7
identification (.SPC and .N42) files	6, 33	dwell time per channel	63
monitoring for radionuclides	31	monitoring count rate	36
Launcher program	8	Shipping	19, 96
LCX (low-confidence expert) Mode	60	Shutdown for long periods/storage	18, 96
MAESTRO	5, 69	SNM Search Mode	2, 38
MCB Properties setup	83	setup	63
Monitor detector state of health	88	Spectrum	
Monitor hardware status	88	Display Mode	35
troubleshooting	79	enter a description	66
Menus		file storage location	67
navigation	22	file transfer to PC	69
Monitor Mode		filename formats	67
portal monitoring	37	hiding the spectrum display	62
rapid surveys	37	identification (.SPC and .N42) files	6, 33
Neutron count rate	64	quantitative analysis	82
Operating cautions	18	search (.CHN) files	37
Password	61	stored (saved) spectra	5
forgetting	77	viewing stored spectra and reports	52
Power		zoom, marker, scaling	35
auto battery adapter cables	16	Survey Mode	1
internal vs. external	16	passive monitoring	29
power source indicator	17, 22	Troubleshooting	75
Power adapter/charger		Windows connectivity	
cautions	18	troubleshooting	78
features	15	Windows 8, 7 (Mobile Device Center)	69
features, illustrated	11	XP (ActiveSync)	71
indicators	15	Wireless communication (IEEE 802.11)	93
placement	15		
setup	15		